

MAIN OFFICE:

49 Herring Pond Road
Buzzards Bay, MA 02532
TEL: (508) 833-0070
FAX: (508) 833-2282



NANTUCKET OFFICE:

19 Old South Road
Nantucket, MA 02554
TEL: (508) 325-0044
www.brackeneng.com

January 25, 2024

RECEIVED

By Bourne Health Department at 1:02 pm, Jan 25, 2024

Hand Delivery & Email [tguarino@townofbourne.com]

Bourne Board of Health
Terri Guarino, RS, CHO
24 Perry Avenue
Bourne, MA 02532

**RE: Bourne Board of Health Variance/Waiver Request – Proposed Septic Upgrade
415 Circuit Avenue (Map 42.4 Parcel 34)**

Dear Members of the Board:

On behalf of the owner/applicant, Gretchen S. Dietrich, please accept this letter as a request for the following variances to 310 CMR 15.00 (Title 5) & the Town of Bourne Health Regulations for a proposed septic installation at the above referenced property. We request the following *Local Upgrade Approval Waivers and Local Variances*:

- **310 CMR 15.405(1)(a) – A 5' Local Upgrade Approval Waiver from full compliance is requested for a 5' setback from a property line (#421 Circuit Avenue) to a soil absorption system.**
- **310 CMR 15.405(1)(a) – A 3' Local Upgrade Approval Waiver from full compliance is requested for a 7' setback from a property line (#421 Circuit Avenue) to a pump chamber.**
- **310 CMR 15.405(1)(a) – A 4' Local Upgrade Approval Waiver from full compliance is requested for a 6' setback from a property line (#54 Hope Avenue) to a septic tank.**
- **310 CMR 15.405(1)(a) – A 5' Local Upgrade Approval Waiver from full compliance is requested for a 5' setback from a property line (#54 Hope Avenue) to a pump chamber.**
- **310 CMR 15.405(1)(a) – A 1' Local Upgrade Approval Waiver from full compliance is requested for a 4' setback from a foundation (#415 Circuit Avenue) to a soil absorption system.**
- **An 84' local variance is requested from the BOURNE BOARD OF HEALTH Regulations for a 66' setback from a proposed soil absorption system to the top of a Coastal Bank.**
- **A 62' local variance is requested from the BOURNE BOARD OF HEALTH Regulations for an 88' setback from a proposed soil absorption system to the Mean High Water line of Pocasset Harbor.**

The proposed project includes the installation of a new Title 5 septic system. No records of the existing septic system are on file at the Bourne Health Office. The site contractor is to locate and remove the existing system in accordance with MA 310 CMR 15.532. The proposed septic system is an Innovative/Alternative (I/A) septic system, consisting of a Singulair DN 960 septic tank, and a Perc-Rite Drip Dispersal System. The employment of I/A technology results in a benefit to the environment by reducing the nitrogen loading from 21.75 ppm to 12.6 ppm or 42%.

Bracken Engineering, Inc. is requesting that the Bourne Board of Health deviate from the goal of full compliance by allowing the *Local Upgrade Approval Waivers and Local Variance* requested above. The above *Local Upgrade Approval Waivers and Local Variances* are being made because of the relatively small lot and its proximity to adjacent resource areas. The design provides the best treatment within the borders of the lot and confines of the existing resource areas.



Thank you for your time and consideration on this matter. We look forward to reviewing this project with the Board of Health at the February 14, 2024 Public Hearing. Should you have any questions regarding this project or require any further information please contact the undersigned at either 508-833-0070 or zac@brackeneng.com

Sincerely,

BRACKEN ENGINEERING, INC.

A handwritten signature in black ink, appearing to read 'Zachary L. Basinski', written over a horizontal line.

Zachary L. Basinski, P.E., CFM
Senior Project Manager

A handwritten signature in black ink, appearing to read 'Jason P. Heyer', written over a horizontal line.

Jason P. Heyer, CFM
Project Designer



Bourne Board of Health Application for Septic Variance or Waiver Requests



In accordance with the established procedures of the Bourne Board of Health, this application is for septic variances and waivers which have not been approved administratively and require approval at a public meeting. Please use the following application form for guidance on how to apply for variances and waivers which serve new construction, changes in use, increases in flow, or repairs and upgrades to on-site sewage disposal systems with design flows of less than 10,000 gallons/ day.

1. Facility Name and Address:

Owner's Name

Gretchen S. Dietrich, Scott R. Dietrich & Guy E. Reed, III

Facility's Street Address

415 Circuit Avenue (Map 42.4, Parcel 34)

Owner's Telephone Number

508-274-6830

Owner's E-mail Address

gsdietrich@earthlink.net

Owner's Mailing Address

PO Box 515, Monument Beach, MA 02553

2. Applicant or Preparer's Name and Address (if different from above):

Preparer's Name

Zachary L. Basinski, PE, CFM

Company

Bracken Engineering, Inc.

Telephone Number

508-833-0070 Ext 303

E-mail Address

zac@brackeneng.com

Mailing Address

49 Herring Pond Road, Buzzards Bay, MA 02532

3. Type of Facility (check all that apply):

Residential Commercial Institutional School Industrial Mixed Use

4. Describe Facility (i.e. single-family dwelling, 45 seat restaurant): _____

Single-family, 4 bedroom dwelling.

5. Type of System Proposed (check all that apply): Conventional Title 5 I/A System

Pumped System Gravity System Pressure Dosed Tight Tank Other

6. Describe the existing and proposed septic system components: Existing - info unavailable

Proposed: Singular 960N 600 GPD denitrification tank (H-20), 1,000 gal. pump chamber (H-20), and Perc-Rite field to be 800 SF effective area with 405 LF of tubing spaced 2' o/c.

7. Design Flow per 310 CMR 15.203 (in gallons/ day):

110 / GPD	EXISTING	PROPOSED
Design flow of system:	440	440
Total design flow of facility: <i>(if more than one system on subject property)</i>	440	448

8. Enclose a **letter of request for variances/waivers** which makes reference to the specific provisions of Title 5 and/ or the Board Bourne of Health Regulations for which a variance is sought. Please use this opportunity to demonstrate compliance with 310 CMR 15.410, and to justify the relevant facts and circumstances of the individual case. Note that with regard to variances for new construction, enforcement of the provision from which a variance is sought must be shown to deprive the applicant of substantially all beneficial use of the subject property in order to be manifestly unjust. Be sure to explain why full compliance with the applicable regulations is not feasible, and how a level of environmental protection that is at least equivalent to that provided under Title 5 and the Board of Health Regulations can be achieved without strict application of said regulations.

9. In order for this Application to be deemed complete, it must be accompanied by the following:

- \$125 filing fee + any other applicable permit application fees paid to the Town of Bourne.
- Application for a Disposal System Construction Permit (may be filled out by installer).
- Six copies of Letter of Request describing nature of variances.
- Six sets of complete engineered plans and specifications, one with original stamp of design engineer; plus, one electronic copy. All variances/ waivers must also be listed on the plans per 310 CMR 15.220(4).
- Six sets of floor plans, **existing** and proposed.
- Six copies of [Nitrogen Loading Calculation Worksheet](#) *required for all applications.
- If abutter notification is required, one of each of the following must be submitted:
 - A copy of the certified list of abutters from the Assessor's Department.
 - Sample letter for abutter notification postmarked 10 days prior to meeting date.
 - Proof of certified mailing (receipts) meeting requirements of 310 CMR 15.405(2).
- Proposals for installation of Innovative/Alternative septic systems must be accompanied by:
 - A copy of the Certification for Use including technology specific conditions.
 - Draft [disclosure notice for the I/A technology](#) to be recorded in the deed.
- Hydrogeologic data may be required for new leaching facilities proposed within 100ft of a wetland/watercourse.
- [Percentage of Increase Worksheet](#) may be required for waivers or increases in flow.

10. Certification:

"I certify under penalty of law that this document and all attachments, to the best of my knowledge and belief, are true, accurate, and complete. I am aware that there may be significant consequences for submitting false information, including, but not limited to, penalties or fine and/or imprisonment for deliberate violations."

Facility Owner's Signature  BRACKEN ENG. INC - AGENT Date 1/25/24
Print Name Zachary L. Basinski, PE, CFM | Bracken Eng. as Agent

Signature of Preparer  BRACKEN ENG. INC - Date 1/25/24
Print Name Zachary L. Basinski, PE, CFM | Bracken Eng.



Town of Bourne - Water Resources Nitrogen Loading and Mitigation Worksheet

See Cape Cod Commission Technical Bulletin 91-001 for further details: https://capecodcommission.org/resource-library/file/?url=/dept/commission/team/Website_Resources/regulatory/NitrogenLoadTechbulletin.pdf

Facility Address: 415 Circuit Avenue
Preparer's Name: Bracken Engineering, Inc.
Date: 1/15/2024
Watershed: Red Brook Harbor

Project Nitrogen Load

Proposed Wastewater

1. Project Title-5 wastewater flows: gpd (a)
 Actual wastewater flows: * (b)
 Average wastewater flows: gpd (a)+(b) ÷ 2= (A)

* Title-5 flows prescribed by TB91-001 for commercial uses

Place in applicable box:

Yes No Will the project be connected to sewer ?
 Yes No Is project Title-5 wastewater flow 10,000 gpd or greater ?

Place in applicable box and multiply unsewered wastewater flow by applicable conversion factor:

<input type="checkbox"/>	Standard Title-5 System (35-ppm-N)	x	0.048359	} Type of system: <input type="text" value="Singular DN 960 & Perc-Rite"/>
<input type="checkbox"/>	DEP-approved I/A System (25-ppm-N)	x	0.034542	
<input checked="" type="checkbox"/>	DEP-approved I/A System (19-ppm-N)	x	0.026252	
<input type="checkbox"/>	DEP-approved Enhanced I/A (12-ppm-N)	x	0.016580	

Wastewater nitrogen load (Title-5 flows) = kg-N/yr (B)
 Wastewater nitrogen load (Actual flows) = kg-N/yr (C)

Existing Conditions

Calculate (A') through (P') as w/ (A) through (P):

Title-5 wastewater flows: gpd
 Actual wastewater flows: *
 Avg. wastewater flows: gpd (A')

Place in applicable box:

Yes No Is existing development on sewer ?
 (If 'Yes', then go to line 2.)

Standard Title-5 System
 DEP-approved I/A System (commercial)
 DEP-approved I/A System (residential)
 DEP-approved enhanced I/A

kg-N/yr (B')
 kg-N/yr (C')
 wastewater offsets

Stormwater Runoff

Town of Bourne Recharge rate for Bourne (inches; for natural areas from Technical Bulletin 91-001): (RECH)

Project site area: acres (D)
 Project site wetland area: acres (E)
 Project site upland area: acres (F)
 Pervious unpaved upland: acres (G)

% using LID Paved area: s.f. (H)
 Factor may be adjusted for employment of LID → x 1.4158E-04
 LID = low impact development = kg-N/yr (I)

Roof area: s.f. (J)
 x 7.0792E-05 = kg-N/yr (K)

Project site area: acres (D)
 Project site wetland area: acres (E)
 Project site upland area: acres (F)
 Pervious unpaved upland: acres (G')

Paved area: s.f. (H')

Paving runoff offset: kg-N/yr (I')

Roof area: s.f. (J')

Roof runoff offset: kg-N/yr (K')

Fertilizer

Previous unpaved upland - roof area =
 Managed turf/ lawn area: s.f.
 x 3.4019E-04 = kg-N/yr (L)

Managed Turf/ lawn area: s.f.
 Fertilizer offset: kg-N/yr (L')



Town of Bourne - Water Resources Nitrogen Loading and Mitigation Worksheet

See Cape Cod Commission Technical Bulletin 91-001 for further details: https://capecodcommission.org/resource-library/file?url=/dept/commission/team/Website_Resources/regulatory/NitrogenLoadTechbulletin.pdf

Facility Address: 415 Circuit Avenue
Preparer's Name: Bracken Engineering, Inc.
Date: 1/15/2024
Watershed: Red Brook Harbor

Total Nitrogen Load		Total project nitrogen load (Title-5 flows): <input type="text" value="12.69"/> kg-N/yr (M)= (B)+(I)+(K)+(L)		Existing nitrogen load (Title-5 flows): <input type="text" value="22.42"/> kg-N/yr (M')	
		Total project nitrogen load (Actual flows): <input type="text" value="5.73"/> kg-N/yr (N)= (C)+(I)+(K)+(L)		Existing nitrogen load (Actual flows): <input type="text" value="9.60"/> kg-N/yr (N')	
		Nitrogen load per acre (Average): <input type="text" value="90.19"/> kg-N/yr/acre (O)= (M)+(N) ÷2 +(F)		Nitrogen offset per acre: <input type="text" value="156.74"/> kg-N/yr/acre (O')	
Proposed Nitrogen Loading Concentration				Existing nitrogen loading concentrations:	
Project nitrogen loading concentration (Title-5 flows): <input type="text" value="14.25"/> ppm-N		(P)= $\frac{(M)}{(a)+723.76 + (G)x(RECH)+9.7286 + (H)+10,594 + (K)+0.75}$		Title-5 flows <input type="text" value="25.18"/> ppm-N (P')	
Project nitrogen loading concentration (Actual flows): <input type="text" value="10.94"/> ppm-N		(Q)= $\frac{(N)}{(b)+723.76 + (G)x(RECH)+9.7286 + (H)+10,594 + (K)+0.75}$		Actual flows <input type="text" value="18.32"/> ppm-N (Q')	
Project nitrogen loading concentration (Average): <input type="text" value="12.60"/> ppm-N		(R)= (P)+(Q) ÷2		Average <input type="text" value="21.75"/> ppm-N (R')	

Resource/ Impact Based Criteria

Marine Water Recharge Areas / Coastal Embayments

2. Yes No Is the project located in any of the following watersheds: **Buttermilk Bay Basins, Phinneys Harbor / Back River / Eel Pond, Pocasset River Basin, Pocasset Harbor / Hen Cove / Red Brook Harbor, Megansett / Squeteague Harbors** ?**
(If 'No', then go to line 3.)

Name of Watershed
(from Regional Policy Plan Data Viewer): RED BROOK HARBOR

Critical Nitrogen-loading limit** : kg-N/year/acre **(S)**

Yes No Does project's nitrogen load **(O)** exceed the existing load **(O')** AND the critical nitrogen load **(S)** ?
(If 'No', then go to line 3.)

Excess project nitrogen load to be mitigated: kg-N/yr **(T)= LESSER OF (O)-(S) x(F) AND (O)-(O') x(F)**

**** When a nitrogen-loading limit has been determined through either a Total Maximum Daily Load (TMDL), a Massachusetts Estuaries Project-accepted technical report, or specified by a Commission-approved comprehensive wastewater management plan pursuant to Objective WR3, or if impaired water quality has been documented for the receiving coastal waters, the nitrogen loading limit shall be 0 kg-N/yr per acre pursuant to Objective WR3.**

Groundwater Quality

3. Yes No Does the project's nitrogen loading concentration in groundwater **(R)** exceed the greater of **5 ppm** or the existing concentration **(R')** ?
(If 'Yes', the project will need to provide an alternative strategy for meeting these thresholds by using another worksheet)

Potential Public Water Supply Areas

4. Yes No Is project in a Potential Public Water Supply Area (PPWSA) ?
(If 'No', then go to line 5.)



Town of Bourne - Water Resources Nitrogen Loading and Mitigation Worksheet

See Cape Cod Commission Technical Bulletin 91-001 for further details: https://capecodcommission.org/resource-library/file/?url=/dept/commission/team/Website_Resources/regulatory/NitrogenLoadTechbulletin.pdf

Facility Address: 415 Circuit Avenue
Preparer's Name: Bracken Engineering, Inc.
Date: 1/15/2024
Watershed: Red Brook Harbor

Does the project's nitrogen loading concentration (R) exceed the greater of 1 ppm or the existing concentration (R) ?
(If 'Yes', the project must provide an alternative strategy for meeting Objective WR1)

Does the project use, treat, generate, store or dispose of hazardous materials in excess of the greater of a) household quantities or b) existing quantities ?
(If 'Yes', the project must provide an alternative strategy for meeting Objective WR1)

Wellhead Protection Areas

5. Is project in a Wellhead Protection Area (WHPA) ?

Does the project's nitrogen loading concentration (R) exceed the greater of 5 ppm or the existing concentration (R) ?
(If 'Yes', the project must provide an alternative strategy for meeting Objective WR1)

Does the project use, treat, generate, store or dispose of hazardous materials in excess of the greater of a) household quantities or b) existing quantities ?
(If 'Yes', the project must provide an alternative strategy for meeting Objective WR1)

Fresh Water Recharge Areas

6. Is project wastewater disposed of within 300 feet of a stream or fresh surface water body?
(If 'No', then go to line 7.)

Is the project located in a freshwater recharge area (FWRA) hydraulically upgradient of a stream or fresh surface water body?
(If 'Yes', the project must provide an alternative strategy for meeting Objective WR2)

Other Potential Impacts

7. Will the project withdraw more than 20,000 gallons of water per day ?
(If 'Yes', then the project must provide documentation demonstrating that there will not be significant impacts to water levels, surface waters and wetlands)

8. **The project must demonstrate compliance with Objective WR4, including use of Low Impact Development to mitigate impacts of stormwater runoff and O & M plans for maintaining stormwater infrastructure and landscaping.**

#415 CIRCUIT AVENUE
EXISTING FLOOR LAYOUT
1/16/2024

PREPARED BY:
BRACKEN BLDG. LLC

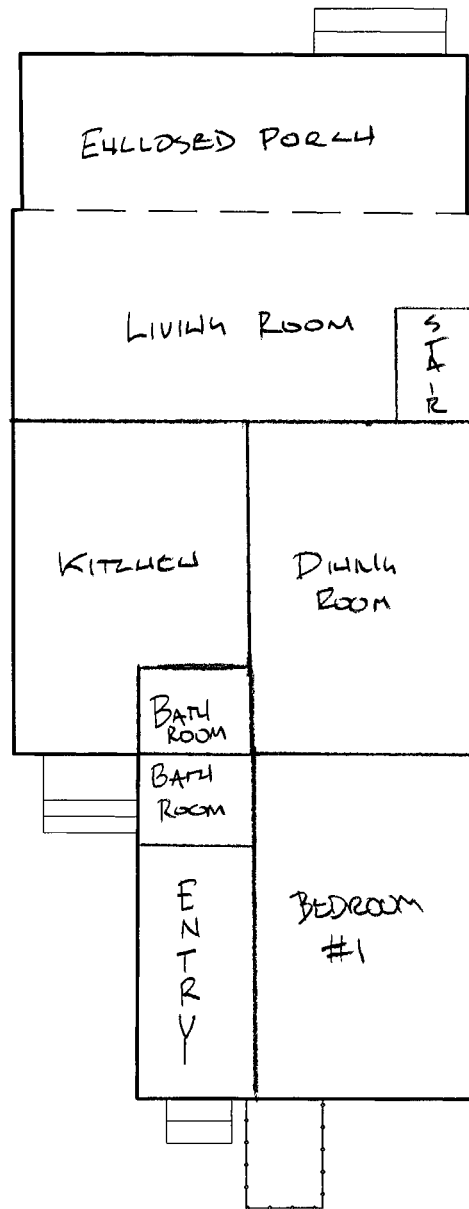

1ST FLOOR
N.T.S.

#415 CIRCUT AVENUE
EXISTING FLOOR LAYOUT
1/16/2024

PREPARED BY:

BRACKEN ENR. LLC

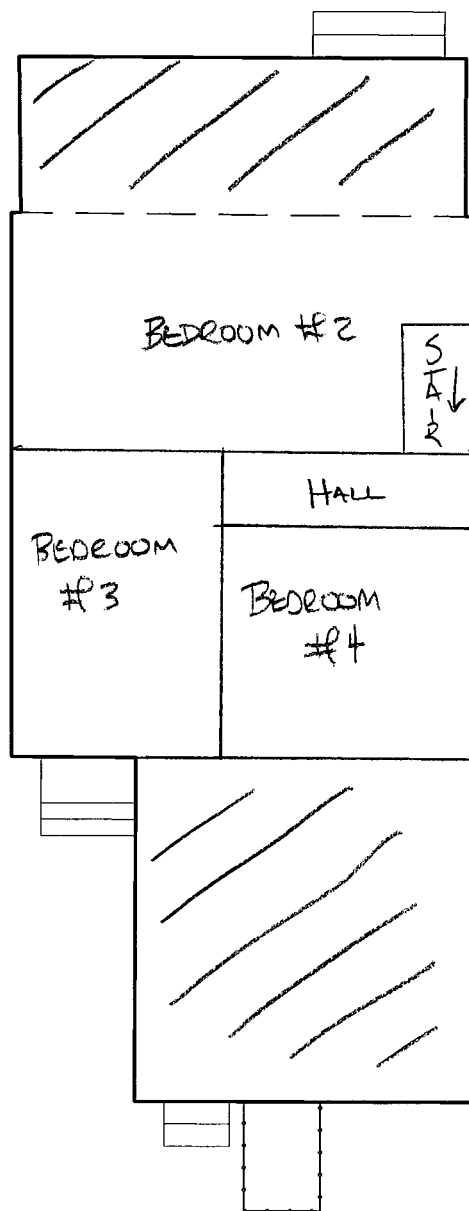

2ND FLOOR
N.T.S

NOTICE OF ALTERNATIVE SEWAGE DISPOSAL SYSTEM
M.G.L. c. 21A, § 13 and 310 CMR 15.287(10)

ADDRESS OF PROPERTY SERVED BY ALTERNATIVE SYSTEM:

415 Circuit Avenue, Bourne, MA

TITLE REFERENCE FOR PROPERTY SERVED BY ALTERNATIVE SYSTEM

Deed recorded with the **Barnstable** Registry of Deeds in **Book 29888, Page 66**

NAME(S) OF OWNER OF PROPERTY SERVED BY ALTERNATIVE SYSTEM:

Gretchen S. Dietrich, Scott R. Dietrich & Guy E. Reed, III

OWNER(S) MAILING ADDRESS: PO Box 515, Monument Beach, MA 02553

WHEREAS, Section 15.280 of Title 5 of the State Environmental Code (“Approval of Alternative Systems”), provides for the Massachusetts Department of Environmental Protection (the “Department”) to approve or certify, as appropriate, all proposals to construct, upgrade or replace on-site sewage disposal systems using alternative systems;

WHEREAS, owners and/or operators of approved or certified alternative systems are subject to general conditions, as specified in Section 15.287 of Title 5 of the State Environmental Code, 310 CMR 15.287, and may be subject to special conditions, as specified in the Department’s approvals or certifications; such general and special conditions potentially including, without limitation, requirements relating to the use of trained operators, periodic inspections, maintenance, sampling, reporting and/or recordkeeping;

WHEREAS, the owners and/or operators this alternative system acknowledges and agrees to comply with the provisions of all of the Bourne Board of Health Alternative Septic System Regulations and any other conditions for the existence of the system;

WHEREAS, Section 15.287(10) of Title 5 of the State Environmental Code, 310 CMR 15.287(10), requires that “prior to obtaining a Certificate of Compliance for installation of a new or upgraded system, the system owner shall record in the chain of title for the property served by the alternative system in the Registry of Deeds and/or Land Registration Office, as applicable, a Notice disclosing both the existence of the alternative on-site system and the Department’s approval of the system. The system owner shall also provide evidence of such recording to the Bourne Board of Health; and

WHEREAS, the Property is served by an alternative sewage disposal system.

NOW, THEREFORE, Notice of an alternative sewage disposal system is hereby given for the above-referenced Property, as follows:

1. Existence System #1. An alternative system has been installed as a new or upgraded alternative sewage disposal system, on or adjacent to the Property, and serves the Property. The trade name and model number(s) of the alternative system are as follows:

Trade name of technology:	<i>Singulair 960 DN</i>
Manufacturer Name:	NORWECO, Inc.
Model number(s):	Model 600

2. Approval/Certification. On 1/3/2019, modified 10/2/2019, the Department, pursuant to its authority under the section of Title 5 as specified below, approved or certified the technology used in the above referenced alternative system, under MassDEP Transmittal Number X281247.

- Approved for General use under 310 CMR 15.288

3. Existence System #2. An alternative system has been installed as a new or upgraded alternative sewage disposal system, on or adjacent to the Property, and serves the Property. The trade name and model number(s) of the alternative system are as follows:

Trade name of technology: PERC-RITE Drip Dispersal System

Manufacturer Name: American Manufacturing Company, Inc.

4. Approval/Certification. On March 4, 2011 and revised March 20, 2015 the Department, pursuant to its authority under the section of Title 5 as specified below, approved or certified the technology used in the above referenced alternative system, under MassDEP Transmittal Number X236091 Approved for remedial use under 310 CMR 15.284

- Approved for Remedial use under 310 CMR 15.284

A copy of the Department of Environmental Protection's Approval/Certification is available online at the Department's website:

<https://www.mass.gov/guides/approved-title-5-innovativealternative-technologies>

This Notice of Alternative Sewage Disposal System must be submitted to the Bourne Board of Health

WITNESS the execution hereof under seal this ____ day of _____, 20____, made by the above-named Alternative System Owner(s).

Gretchen S. Dietrich

Scott R. Dietrich

COMMONWEALTH OF MASSACHUSETTS

_____, ss

On this ____ day of _____, 20__, before me, the undersigned notary public, personally appeared Gretchen S. Dietrich and Scott R. Dietrich who proved to me through satisfactory evidence of identification, which was _____, to be the persons whose names are signed on the preceding or attached document, and acknowledged to me that he & she signed it voluntarily for its stated purpose.

(official signature and seal of notary)

WITNESS the execution hereof under seal this ____ day of _____, 20____, made by the above-named Alternative System Owner(s).

Guy E. Reed, III

STATE OF _____

_____, ss

On this ____ day of _____, 20__, before me, the undersigned notary public, personally appeared Guy E. Reed, III who proved to me through satisfactory evidence of identification, which was _____, to be the persons whose names are signed on the preceding or attached document, and acknowledged to me that he & she signed it voluntarily for its stated purpose.

(official signature and seal of notary)

Approved and Accepted By:

Agent for the Board of Health
Health Department
Town of Bourne



Commonwealth of Massachusetts
Executive Office of Energy & Environmental Affairs

Department of Environmental Protection

One Winter Street Boston, MA 02108 • 617-292-5500

Charles D. Baker
Governor

Karyn E. Polito
Lieutenant Governor

Matthew A. Beaton
Secretary

Martin Suuberg
Commissioner

APPROVAL FOR REMEDIAL USE

Pursuant to Title 5, 310 CMR 15.000

Name and Address of Applicant:

American Manufacturing Company, Inc.
22011 Greenhouse Road, P.O. Box 97
Elkwood, VA 22718

Trade name of technology and model: PERC-RITE Drip Dispersal System, Models QM(WD), ASD-15, ASD-25 & ASD-40 (hereinafter called the "System"). A schematic drawing of a typical System, a Design Manual and a technology checklist are attached and are a part of this Approval.

Transmittal Number: X236091
Date of Issuance: March 4, 2011, revised March 20, 2015

Authority for Issuance

Pursuant to Title 5 of the State Environmental Code, 310 CMR 15.000, the Department of Environmental Protection hereby issues this Approval for Remedial Use to: American Manufacturing Company, PO Box 97, Elkwood, VA 22718 (hereinafter "the Company"), approving the System described herein for remedial use in the Commonwealth of Massachusetts. Sale and use of the System are conditioned on compliance by the Company and the System owner with the terms and conditions set forth below. Any noncompliance with the terms or conditions of this Approval constitutes a violation of 310 CMR 15.000.

David Ferris, Director
Wastewater Management Program
Bureau of Water Resources

March 20, 2015
Date

I. Purpose

1. The purpose of this Approval is to allow use of the System in Massachusetts to repair subsurface sewage disposal systems, on a Remedial Use basis.
2. With the necessary permits and approvals required by 310 CMR 15.000, this Approval for Remedial Use authorizes the use and installation of the System in Massachusetts.
3. The System may only be installed on facilities that meet the criteria of 310 CMR 15.284(2). The System is used to dispose of wastewater from an alternative system approved in accordance with 310 CMR 15.280 through 15.289 with effluent discharge concentrations that meet or exceed secondary treatment standards of 30 mg/L biochemical oxygen demand (BOD5) and 30 mg/L total suspended solids (TSS), and from conventional Title 5 septic systems.
4. This Approval for Remedial Use authorizes the use of the System where the local approving authority finds that the System is for upgrade of a failed, failing or nonconforming system and the design flow for the facility is less than 10,000 gallons per day (GPD).

II. Design and Construction Standards Standards

1. The System, a subsurface drip distribution technology, is equivalent to a pressure distribution system designed in accordance with the Department's Pressure Distribution Guidance. In the event of conflict between the terms and conditions of this System's technology approval and Title 5, this approval shall control.
2. The System is a pressure distributed subsurface wastewater drip dispersal (disposal) system that replaces a soil absorption system (SAS) designed in accordance with 310 CMR 15.000. The System is designed to distribute effluent from a treatment system (I/A or conventional) and discharge it at a minimum depth of 6 inches below finished grade; it includes a pump, control panel, a filter module/hydraulic unit and drip dispersal zone(s). The dispersal zone includes small diameter flexible polyethylene tubing with pressure compensating emitters located at two foot spacing within the tubing. The emitters operate on a pressure differential across the emitter. Effluent wastewater is discharged in small doses from the emitters. Dispersal field dosing is timed and controlled electronically to provide pre-programmed volumes of effluent for discharge to each dispersal zone. The System includes a return line that allows periodic flushing of the dispersal tubing. All drip zone supply and return pipes that are maintained filled with effluent after a pump cycle shall be buried below the frost line or properly insulated. All drip tubing and shallow manifolds shall be designed to drain into the soil or back to the pump chamber upon completion of the pump cycle. The System shall include single (the QM/WD model) or two-stage (the ASD models) automatic backwashing disc filters within the filter module and air vents in each dispersal zone. Each zone shall have air release valves at the high points of manifolds and check valves on each return manifold in multi-zone systems. The system shall be equipped with a totalizing flow meter.
3. The System may be installed in the A, B or C soil horizon or in fill material meeting the specifications at 310 CMR 15.255(3) at a minimum depth of 6 inches below the finished grade.
4. All access ports and manhole covers shall be installed and maintained at grade to allow for maintenance of the System.

5. The control panel including alarms and controls shall be mounted in a location always accessible to the System operator.
6. The System may be installed in soils with a percolation rate of up to 90 minutes per inch (MPI). The System shall not be installed in Class IV soils as defined in 310 CMR 15.243.
7. Effluent loading rates shall be as specified in 310 CMR 15.242(1)(a) and (b) with the exception of Class IV soils.
8. The System shall be designed and constructed with drip tubing with a spacing of 24 inches unless obstructions are encountered or in cases where more than the required tubing is provided and equally distributed within the approved appropriately sized subsurface disposal area in which case a minimum separation of 12 inches is allowed. As much as possible the System shall be designed to provide equal distribution across the designated disposal area.
9. The System does not require a five foot over dig as indicated at 310 CMR 15.255(5).
10. The System includes the following:
 - a. Pumps capable of providing pressure of 10-60 psi throughout the dispersal zone(s). Each drip dispersal zone shall be dosed a minimum of four times per day, or as recommended by the Company. Duplex pumping shall be provided for facilities with design flows of 2000 gpd or greater. The pump chamber, combined with available storage in the pretreatment units if provided, shall provide at least one-day storage as required by 310 CMR 15.231.
 - b. Timed dosing for the drip system with a timer controller capable of operating the system during peak flow events without high-level alarms.
 - c. Automatically backwashed filter(s) capable of screening particles larger than 115 microns prior to discharge of the effluent to the drip tubing. Filter(s) backwash shall be conveyed back to a separate settling tank or to the septic tank.
 - d. Air vents in a zone shall be placed at a higher elevation than the drip tubing in that zone but below the ground surface. Air vents shall be accessible from finished grade and insulated to prevent freezing.
 - e. Drip tubing lines installed as level as possible on contour and a minimum of 6 inches below finished grade. Drip line spacing is typically 24 inches with drip tubing emitters spaced 24 inches on center. More than the minimum length of tubing may be utilized within a properly sized soil absorption system. When the drip lines spacing is greater than 24 inches by 24 inches, the size of the dispersal field shall be increased to provide equal distribution with adequate tubing separation. The drip dispersal tubing shall be automatically forward flushed after a pre-programmed number of dosing cycles as determined by the Company. Flushing velocity shall be at least 2 feet per second at the distal end(s) of each drip dispersal lateral within a zone. All drip line flushwater shall be conveyed back to a separate settling tank or to septic tank.
 - f. The effective effluent dispersal area is calculated using the total area of the drip tubing system including a one-foot addition on each side or two square feet per foot of drip tube when tubing is spaced two feet apart. No sidewall credit shall be given for this System.

2. Any required operation and maintenance, monitoring and testing shall be performed in accordance with a Department approved plan.
3. The facility served by the System and the System itself shall be open to inspection and sampling by the Department and the local approving authority at all reasonable times.
4. In accordance with applicable law, the Department and the local approving authority may require the System owner to cease operation of the system and/or to take any other action as it deems necessary to protect public health, safety, welfare and the environment.
5. The Department has not determined that the performance of the System will provide a level of protection to public health and safety and the environment that is at least equivalent to that of a sewer system. No System shall be installed, upgraded or expanded, if it is feasible to connect the facility to a sanitary sewer, unless as allowed by 310 CMR 15.004. When a sanitary sewer connection becomes feasible, the facility served by the System shall be connected to the sewer, within 60 days of such feasibility, and the System shall be abandoned in compliance with 310 CMR 15.354, unless a later time is allowed, in writing, by the approving authority.
6. Design, installation and operation shall be in strict conformance with the Company's DEP approved plans and specifications, 310 CMR 15.000 and this Approval.

V. Conditions Applicable to the System Owner

1. The System is approved for the treatment and disposal of sanitary sewage only. Any wastes that are non-sanitary sewage generated or used at the facility served by the System shall not be introduced into the System and shall be lawfully disposed.
2. The System owner shall have the Company or its designee conduct a design review for any proposed non-residential System or any residential System with a design flow 2,000 GPD or greater to ensure that the proposed use of the System is consistent with the unit's capabilities.
3. Operation and Maintenance Agreement:
 - A. Throughout its life, the owner shall operate and maintain the System in accordance with the Company and designer's operation and maintenance requirements and this Approval. To ensure proper operation and maintenance (O&M), the owner shall enter into an O&M agreement. No O&M agreement shall be for less than one year.
 - B. No System shall be used until an O&M agreement is submitted to the approving authority which provides for the contracting of a person or firm trained by the Company as provided in Section VI (5) and competent in providing services consistent with the System's specifications, with the operation and maintenance requirements specified by the Company and the designer, and with any specified by the Department. The O&M agreement shall also contain procedures for notification to the Department and the local board of health within five days of a System failure or alarm event and for corrective measures to be taken immediately. It shall also require the System inspector, at each site visit and anytime there is an alarm event, to conduct an inspection using the Company's technology checklist of the System's filter system, pumps, valves, etc., disposal area where the System is installed for signs of breakout or dampness and complete any required maintenance. The System owner

shall at all times have the System properly operated and maintained in accordance with this Approval, the designer's operation and maintenance requirements and the Company's approved procedures and sampling protocols. The System owner shall notify the Department and the local approving authority in writing within seven days of any cancellation, expiration or any other change in the terms and/or conditions of their O&M agreement.

4. Prior to transferring any or all interest in the property served by the System, or any portion of the property, including any possessory interest, the System owner shall provide written notice of all conditions contained in this Approval to the transferee(s). Any and all instruments of transfer and any leases or rental agreements shall include as an exhibit attached thereto and made a part thereof a copy of this Approval for the System. The System owner shall send a copy of such written notification(s) to the Department and local approving authority within 10 days of such notice being given.
5. By January 31st of each year for the previous year, the System owner shall submit to the local approving authority all data collected in accordance with item 3, above, including all Department Title 5 IA O&M checklists and System technology checklists completed during the previous calendar year by the System operator for each inspection performed
6. After final inspection of the System by the Approving Authority but prior to the issuance of a Certificate of Compliance for the System, the System owner shall record and/or register in the appropriate Registry of Deeds and/or Land Registration Office, a Notice disclosing both the existence of the alternative septic system subject to this Approval on the property and the Department's approval of the System. If the property subject to the Notice is unregistered land, the Notice shall be marginally referenced on the owner's deed to the property. Within 30 days of recording and/or registering the Notice, the System owner shall submit the following to the Department and the local approving authority: (i) a certified Registry copy of the Notice bearing the book and page/instrument number and/or document number; and (ii) if the property is unregistered land, a Registry copy of the owner's deed to the property, bearing the marginal reference.

VI. Conditions Applicable to the Company

1. The Company shall notify the Director of the Wastewater Management Program at least 30 days in advance of the proposed transfer of ownership of the technology for which this Approval issued. Said notification shall include the name and address of the proposed new owner and a written agreement between the existing and proposed new owner containing a specific date for transfer of ownership, responsibility, coverage and liability between them. All provisions of this Approval applicable to the Company shall be applicable to successors and assigns of the Company, unless the Department determines otherwise.
2. The Company shall develop and submit to the Department within 60 days of the effective date of this Approval: minimum installation requirements; an operating manual, including information on substances that should not be discharged to the System; and a recommended schedule for maintenance of the System essential to consistent successful performance of the installed Systems.

3. The Company shall make available, in print and electronic format, the referenced procedures and protocol in Section VI (3) to owners, operators, designers and installers of the System.
4. The Company shall institute and maintain a program of operator training and continuing education, as approved by the Department. The company shall update the list of qualified operators and make the list known to users of the technology.
5. The Company or its designee shall conduct a design review for any proposed non-residential System or any residential System with a design flow 2,000 GPD or greater to ensure that the proposed use of the System is consistent with the unit's capabilities.
6. The Company shall furnish the Department any information that the Department requests regarding the System within 21 days of the receipt of that request.
7. The Company shall include copies of this Approval and the procedures and protocol described in Section VI (3) for each System that is sold. Also, in any contract executed by the Company for distribution or re-sale of the System, the Company shall require the distributor or re-seller to provide each purchaser of the System with copies of this Approval and the procedures and protocol described in Section VI (3).
8. The Company shall comply with 310 CMR 15.000 and all the Department policies and guidance that apply and as they may be amended from time to time.

VII. Reporting

1. All notices and documents required to be submitted to the Department by this Approval shall be submitted to:

Director
Wastewater Management Program
Department of Environmental Protection
One Winter Street - 5th floor
Boston, Massachusetts 02108

VIII. Rights of the Department

1. The Department may suspend, modify or revoke this Approval for cause, including, but not limited to, non-compliance with the terms of this Approval, non-payment of the annual compliance assurance fee, for obtaining the Approval by misrepresentation or failure to disclose fully all relevant facts or any change in or discovery of conditions that would constitute grounds for discontinuance of the Approval, or as necessary for the protection of public health, safety, welfare or the environment, and as authorized by applicable law. The Department reserves its rights to take any enforcement action authorized by law with respect to this Approval and/or the System against the owner, or operator of the System and/or the Company.



Commonwealth of Massachusetts
Executive Office of Energy & Environmental Affairs

Department of Environmental Protection

One Winter Street Boston, MA 02108 • 617-292-5500

Charles D. Baker
Governor

Karyn E. Polito
Lieutenant Governor

Matthew A. Beaton
Secretary

Martin Suuberg
Commissioner

CERTIFICATION FOR GENERAL USE

Pursuant to Title 5, 310 CMR 15.000

Name and Address of Applicant:

NORWECO, Inc.
220 Republic Street
Norwalk, OH 44857

Trade name of technology and models: **Singular 960 DN, model 600, 750, 1000, 1250 and 1500; and Singular 960 DN Green, model 600** (all hereinafter the “System” or the “Technology”) for facilities with design flows less than 2,000 gallons per day (gpd). Schematic drawings illustrating each of the models and an Inspection Checklist are attached and are part of this Certification.

Transmittal Number: X281247
Date of Issuance: January 3, 2019
Modified October 2, 2019 (adding the missing model # 1250)

Authority for Issuance

Pursuant to Title 5 of the State Environmental Code, 310 CMR 15.000, the Department of Environmental Protection (hereinafter “the Department”) hereby issues this General Use Approval to: NORWECO, Inc., 220 Republic Street, Norwalk, OH 44857 (hereinafter “the Company”), approving the above referenced **Singular 960 DN** and **Singular 960 DN Green** (herein after “the Technology” or “System”) for use in the Commonwealth of Massachusetts. Sale and use of the Technology are subject to compliance by the Company, the Designer, the System Installer, the Operator, and the System Owner with the terms and conditions herein. Any noncompliance with the terms or conditions of this Certification constitutes a violation of 310 CMR 15.000

/signed/

Marybeth Chubb, Section Chief
Bureau of Water Resources
Wastewater Management Program

October 2, 2019

Date

This information is available in alternate format. Contact Michelle Waters-Ekanem, Director of Diversity/Civil Rights at 617-292-5751.

TTY# MassRelay Service 1-800-439-2370

MassDEP Website: www.mass.gov/dep

Printed on Recycled Paper

I. Purpose

1. Subject to the conditions of this Approval and any other local requirements, the purpose of this Approval is to allow the use of the System in Massachusetts on a General Use basis. With the necessary permits and approvals required by 310 CMR 15.000, this Certification authorizes the installation and use of the System in Massachusetts.
2. The System may be installed for residential facilities with design flow less than 2,000 gallons per day (gpd) where a system in compliance with 310 CMR 15.000 exists on-site or could be built and for which a site evaluation in compliance with 310 CMR 15.000 has been approved by the Local Approving Authority (LAA); or by the Department if Department approval is required by 310 CMR 15.000. This Approval allows for the use of the System on facilities for nitrogen reduction in a Department designated nitrogen sensitive or limited area as defined in 310 CMR 15.214 and 15.215.

Non-residential facilities are not allowed under this approval. Non-residential facilities include properties with businesses and/or commercial establishments.

3. The System is approved for use at facilities with a maximum design flow of less than 2,000 gpd and shall meet or exceed the following effluent discharge requirements:
 - Effluent Total Nitrogen (TN) concentration of 19 mg/L (for 660 gallons per day per acre (gpda) loading) or 25 mg/L (for 550 gpda loading).
 - Effluent pH range shall be 6.0 to 9.0
4. The System Owner or the designated System Operator (or ‘Operator’) has responsibility for oversight and sampling of the System if the property served was allowed to increase the discharge rate per acre above 440 gpda in an area subject to Nitrogen Loading Limitations.

The System Owner will be required to repair, replace, modify or take any other actions as required by the Department or the LAA, if the Department or the LAA determine that the System is not capable of meeting the required reduction in nitrogen in the effluent.

The Company is responsible for the approved technology as described below:

II. General Description of the Technology

1. The System is installed between the building sewer and the soil absorption system (SAS) of a standard Title 5 system in a manner which neither intrudes on, replaces a component of, or adversely affects the operation of a Title 5 system constructed in accordance with 310 CMR 15.000, subject to the provisions of this Approval.
2. Systems designed for flow more than 1,000 gpd require installation of a pretreatment-septic tank sized in accordance with the Company’s requirements and constructed in accordance with 310 CMR 15.223 through 15.226.
3. The System utilizes extended aeration, activated sludge and filtration to treat sanitary wastewater. The treatment process takes place in a three-compartment processing tank made of precast concrete or similarly sized three-compartment plastic tank (*Singulair 960 DN Green*). The first compartment is a pretreatment chamber for settling solids that provides some anaerobic decomposition during an approximate 12-hour residence time. The second chamber is for aeration, an aerator motor with an aspirator shaft draws air

into the water providing 30 minutes per hour of aeration. The third chamber provides settling and clarification of the aerated wastewater. Activated sludge is recirculated to the aeration chamber by the Bio-Static sludge return located within the third chamber. Approximately 10 to 15 percent of the design flow is returned to the aeration tank. A Bio-Kinetic System is located within the settling zone in the clarification chamber. The Bio-Kinetic System (or filter) provides non-mechanical flow equalization using inflow ports (located for design flow, sustained flow and peak flow), filtration and final settling prior to effluent discharge. The treated wastewater from the Bio-Kinetic System discharges from the Singlair processing tank to a recirculation chamber. A small pump located within the recirculation chamber (vertical oriented plastic pipe) re-circulates approximately 12% to 18% of the treated wastewater to the inlet pipe of the processing tank's first chamber. This process provides the required food source for the completion of the de-nitrification process. The pump discharges the remainder of the effluent either to a final pump chamber and pressure distributed soil absorption system (SAS) or to a distribution box for gravity discharge to a soil absorption system (SAS).

4. *For Singlair 960 DN Green Special Considerations:*

The Singlair Green model installations with plastic tank are not designed for traffic loading. No Green System shall be located or installed in a vehicle traffic area. Siting of the 960 DN Green 600 in a location subject to vehicular loading is specifically prohibited by this Approval. Where vehicles can possibly access an installed Singlair Green System site, suitable warnings shall be installed. The maximum burial depth for the Singlair Green model shall not exceed 16.5 inches. For deeper burials the System Designer shall consult with NORWECO, Inc. and their 'Deeper Burial Requirements' for the Green plastic tank model.

5. *For Buoyancy Calculation Requirement:*

All proposed Singlair installations, including the Green model, shall require buoyancy calculations in locations with high groundwater elevation. Tie downs and associated anchors, such as the anti-flotation beams available from NORWECO, Inc, may be required to prevent tank floatation. The buoyancy calculations shall be included on the Title 5 septic system plan for each System installation. System buoyancy calculations shall include consideration of the high groundwater elevation developed as required by 310 CMR 15.100 through 15.105. Design plans prepared in accordance with 310 CMR 15.220 shall include System anchoring and backstay details when necessary.

6. The System includes a weather-tight enclosed control panel with aerator controls, manual reset circuit breaker, on-off automatic selector switch, adjustable timer mechanism and an audible/visual warning system to report malfunctions. The panel also contains the recirculation pump controls including high water level override and high water alarm. The alarm and control circuits are each connected to an independent power source run from the main power source of the facility. The control panel including alarms are mounted in a location accessible to the operator (or Service Contractor) of the System.

7. All access ports and manhole covers shall be readily removable, of durable material and installed and maintained at grade to allow for maintenance of the System. No structures shall be located directly upon or above the access locations which could interfere with performance, access, inspection, pumping, or repair. Sufficient access for infrequent

maintenance of the System treatment media and all other treatment works shall be evaluated, and addressed in the System design if necessary, by the designer.

8. Wastewater Loading and Effluent Concentration Design Standards

For new residential construction in an area subject to the Nitrogen Loading Limitations of 310 CMR 15.214, and the facility does not meet with the Nitrogen Loading Limitations pursuant to the aggregation provision of 310 CMR 15.216, an increase in calculated loading per acre is allowed for facilities with design flow less than 2,000 gpd with limitations as follows:

- The design flow shall not exceed 660 gpda and the total nitrogen (TN) concentration in the effluent shall not exceed 19 mg/L; or
- The design flow shall not exceed 550 gpda and the total nitrogen (TN) concentration in the effluent shall not exceed 25 mg/L.
- TN is measured as the total of TKN (Total Kjeldhal Nitrogen), NO₃-N (Nitrate Nitrogen) and NO₂-N (Nitrite nitrogen).

III. General Conditions

1. The provisions of 310 CMR 15.000 is applicable to the use and operation of this System, the System owner and the Company, except those that specifically have been varied by the terms of this Certification.
2. The use of the Technology under this Approval requires:
 - Disclosure Notice in the Deed to the property;
 - Certifications by the Company, the Designer, and the Installer;
 - System Owner Acknowledgement of Responsibilities;
 - A certified operator under contract for periodic inspection and maintenance;
 - Periodic sampling;
 - Recordkeeping and reporting; and
 - An external power supply.
3. Any required operation and maintenance, monitoring and testing shall be performed in accordance with this approval. Any required sample analysis shall be conducted by an independent U.S. EPA or DEP approved testing laboratory, or a DEP approved independent university laboratory, unless otherwise provided in the Department's written approval. It shall be a violation of this Certification to falsify any data collected pursuant to an approved testing plan, to omit any required data or to fail to submit any report required by such plan.
4. The facility served by the System and the System itself, shall be open to inspection and sampling by the Department and the LAA at all reasonable times.
5. In accordance with applicable law, the Department and the LAA may require the System owner to cease operation of the system and/or to take any other action as it deems necessary to protect public health, safety, welfare or the environment.
6. The Department has not determined that the performance of the System will provide a level of protection to public health and safety and the environment that is at least equivalent to that of a sanitary sewer system. Accordingly, no System shall be upgraded or expanded, if

it is feasible to connect the facility to a sanitary sewer, unless as allowed by 310 CMR 15.004.

7. Design, installation, and use of the System shall be in strict conformance with the Company's DEP approved plans and specifications and 310 CMR 15.000, subject to this Certification.
8. An authorized agent of the Company must certify to the Approving Authority in writing that the installation was done by a qualified Installer approved by the Company and the installation conforms to this Approval. The authorized agent of the Company responsible for the inspection of the installation shall have received technical training in the Company's products.

IV. Conditions Applicable to the System Owner

1. The System owner shall at all times have the System properly operated and maintained by a Company approved Operator in accordance with this Certification, the designer's operation and maintenance requirements and the Company's approved procedures.
2. The System is certified only in connection with the discharge of sanitary wastewater from residential facilities with a design flow of less than 2,000 gpd. Any non-sanitary wastewater generated and/or used at the facility served by the System shall not be introduced into the System and shall be lawfully disposed of.
3. The System Owner shall provide access to the site for the System Operator to perform inspections, maintenance, repairs, responding to alarm events, field testing, and sampling as may be required by the Approval.

Operation and Monitoring Requirements

4. System effluent total nitrogen (TN) concentrations shall not exceed 19 or 25 mg/L and effluent pH shall not be less than 6.0 or more than 9.0. Field test observations of dissolved oxygen (DO) shall equal or exceed 2 mg/L and for Turbidity shall be equal or less than 40 NTU.
5. All samples shall be taken at a flowing discharge point, i.e. distribution box, pipe entering a pump chamber or other Department approved location from the treatment unit.
6. Inspection, operation and maintenance (O&M), sampling, and field testing of the System required by the Approval shall be performed by a Company approved Operator who has been certified at a minimum of Grade Level 4 (four) by the Board of Registration of Operators of Wastewater Treatment Facilities, in accordance with Massachusetts regulations 257 CMR 2.00, and is an approved Title 5 System Inspector in accordance with 310 CMR 15.340.
7. Prior to commencement of construction of the System, the System Owner shall provide to the LAA a copy of a signed O&M Agreement that meets the requirements of Section IV, paragraph (8).
8. The System Owner shall maintain, at all times, an O&M Agreement with a qualified System Operator approved by the Company. The Agreement shall be at least for one year and include the following provisions:

- a) The name of a System Operator who is an approved System Inspector accordance with 310 CMR 15.340 and who meets any additional qualification requirements specified in the Approval:
 - b) The System Operator must inspect the Alternative System as required by Section IV, paragraph (9) and (12);
 - c) The System Operator shall be responsible for submitting the monitoring results to the System Owner in accordance with Section IV, paragraph (13) and to the LAA in accordance with Section IV, paragraph (14); and
 - d) In the case of a System failure, alarm event, components not functioning as designed, or violations of the Approval, procedures and responsibilities of the System Operator and System Owner shall be clearly defined for corrective measures to be taken immediately. The System Operator shall agree to provide written notification within five days, describing corrective measures taken, to the System Owner and the LAA.
9. The System Owner shall comply with the following monitoring requirements if the System is subject to a TN concentration limit in accordance with Section II, paragraph (6):
- a) Properties occupied at least 6 months per year are considered year-round properties, shall be inspected and have effluent sampled for at least the TN parameter quarterly for the first year, then a minimum of twice/year thereafter, at least 5 months apart and with at least one sample taken between December 1 and March 1 of each year. Field testing shall be completed per Section IV, paragraph (11) below and as determined by the System Operator. See DEP Testing Protocol at <https://www.mass.gov/files/documents/2016/08/wp/testsamp.pdf>. Wastewater flow shall be recorded at each inspection, see 'Flow Metering' Section IV, paragraph (10).
 - b) Properties occupied less than 6 months per year are considered seasonal properties, shall be inspected and have effluent sampled for at least the TN parameter a minimum of twice/year. At least one sample must be taken 30 to 60 days after each seasonal occupancy begins. A second must be taken no less than 2 months after the first sample. Field testing shall be completed per Section IV, paragraph (11) below and as determined by the System Operator. Wastewater flow shall be recorded at each inspection, see 'Flow Metering' Section IV, paragraph (10).
 - c) Systems in operation prior to issuance of this Approval, which have received approval of sampling reduction from the Department may continue with that System monitoring frequency.
- TN is measured as the total of TKN (Total Kjeldhal Nitrogen), NO₃-N (Nitrate nitrogen) and NO₂-N (Nitrite nitrogen).
10. Flow Metering: Reporting of residential System water use is not required, however it is recommended the Operator record water meter readings if available at all inspections, or otherwise estimate System flow, to assist in addressing possible operational problems or issues. Flow measurement when recorded shall be based on:
- a) Actual metering data of wastewater flow to the System or actual water meter data of flow to fixtures that discharge to the wastewater system; or

- b) Actual water meter data for the total facility with either actual meter data or estimated flows for non-wastewater usage subtracted from the total facility water usage. If estimating the wastewater portion of metered water usage, the System Operator shall provide a best estimate of wastewater discharged to the System with method of estimating, such as pump run times, occupancy rates, adjustment due to seasonal outdoor watering use, etc.; or
 - c) For Systems installed under a prior Approval that did not include a wastewater flow data reporting requirement, if no flow meters are available, the System Operator shall provide a best estimate of wastewater discharged to the System with the method of estimating, such as pump run times, occupancy rate, etc.; and
11. Field Testing: Temperature, Turbidity, pH and DO shall be measured and recorded in the field whenever the effluent is sampled for TN. See applicable sections of the Department's Field Testing Protocol at <http://www.mass.gov/files/documents/2016/08/wp/testsamp.pdf>.
12. At minimum, the System Operator shall inspect the System:
- a) Quarterly for the first year then two times per year thereafter;
 - b) In accordance with the approved O&M manual, the Designer's operation and maintenance requirements, and the requirements of the LAA; and
 - c) Any time there is an alarm event, equipment failure, or system failure.

Recordkeeping and Reporting

13. Within 60 days of any site visit, the System Operator shall submit an O&M report and inspection checklist to the System Owner and the Company. It is recommended the System Owner and Company maintain copies of these items for possible Department audit. The O&M report shall include, at a minimum:
- a) For a System failing, any corrective actions taken;
 - b) Wastewater analyses, wastewater flow data, field testing results and inspection checklists;
 - c) Any violations of the Approval;
 - d) Any determinations that the System or its components are not functioning as designed or in accordance with the Company specifications; and
 - e) Any other corrective actions taken or recommended.
14. By February 15th of each year the System Owner or the System Operator if designated by the owner, shall submit to the LAA all monitoring results with all O&M reports and inspection checklists completed by the System Operator during the previous 12 months.
15. Upon determining that the System has failed, as defined in 310 CMR 15.303, the System Operator shall notify the System Owner immediately.
16. Upon determining that the System has failed, as defined in 310 CMR 15.303, the System Owner and the System Operator shall be responsible for the notification of the LAA within 24 hours of such determination.

17. The System Owner shall notify the Approving Authority and the Company in writing within seven days of any cancellation, expiration or any other change in the terms and/or conditions of the O&M Agreement required by Section IV, paragraph (8).
18. Violations of the TN concentration in the System effluent shall not constitute a failure of the System for the purposes of 24-hour notification or 5-day written reporting as required in Section IV, paragraph (8)(d) and (16).
19. The System owner shall provide a copy of this Approval, prior to the signing of a purchase and sale agreement for the facility served by the System or any portion thereof, to the proposed new owner.
20. The System owner shall furnish the Department any information that the Department requests regarding the System, within 21 days of the date of receipt of the request.
21. Prior to issuance of a Certificate of Compliance of the System, and after recording and/or registering the Notice required by 310 CMR 15.287(10) the System Owner shall provide to the LAA a copy of: (i) a certified Registry copy of the Notice bearing the book and page/or document number: and (ii) if the property is unregistered land, a Registry copy of the System Owner's deed to the property, bearing a marginal reference on the System Owner's deed to the property. The Notice to be recorded shall be in the form of the Notice provided by the Department.
22. Prior to signing any agreement to transfer any or all interest in the property served by the System, or any portion of the property, including any possessory interest, the System Owner shall provide written notice of all conditions contained in the Approval to the transferee(s). Any and all instruments of transfer and any leases or rental agreements shall include as an exhibit attached thereto and made a part of thereof a copy of the Approval for the System. The System Owner shall send a copy of such written notification(s) to the LAA within 10 days of giving such notice to the transferee(s).

V. Conditions Applicable to the Company

1. The Company shall notify the Director of the Wastewater Management Program at least 30 days in advance of the proposed transfer of ownership of the technology for which this Certification is issued. Said notification shall include the name and address of the proposed new owner and a written agreement between existing and proposed new owner containing a specific date for transfer of ownership, responsibility, coverage and liability between them. All provisions of this Certification applicable to the Company shall be applicable to successors and assigns of the Company, unless the Department determines otherwise.
2. The Company shall develop, maintain and update as necessary the following:
 - Minimum installation requirements;
 - An operating manual, including information on substances that should not be discharged to the System;
 - A maintenance checklist; and
 - A recommended schedule for maintenance of the System consistent with the Department's requirements essential to consistent successful performance of the installed Systems.

3. The Company shall institute and maintain a program of operator training and continuing education. The Company shall maintain and annually update, and make available the list of qualified operators by February 15th and make the list known to LAA, the Department and to users of the technology.
4. The Company shall furnish the Department any information that the Department requests regarding the System, within 21 days of the date of receipt of that request.
5. The Company shall include copies of this Certification and the procedures described in Section V, paragraph (3) with each System that is sold. In any contract executed by the Company for distribution or re-sale of the System, the Company shall require the distributor or re-seller to provide each purchaser of the System with copies of this Certification and the procedures described in Section V, paragraph (3).
6. A copy of the wastewater analyses, wastewater flow data, field testing results, and System Operator O&M reports and inspection checklists from each installed System shall be maintained by the Company or its designee for possible Department audit.

VI. Conditions Applicable to the System Designer

1. Upon submission of an application for a Disposal System Construction permit, the Designer shall provide to the LAA:
 - a) A certification, signed by the owner of record for the property to be served by the System, stating that the property owner:
 - i. has been provided a copy of the Approval, the Owner's Manual, and the Operation and Maintenance Manual, if applicable, and the owner agrees to comply with all terms and conditions;
 - ii. has been informed of all the owner's costs associated with the operation, including, when applicable: power consumption, maintenance, sampling, recordkeeping, reporting, and equipment replacement;
 - iii. understands the requirement for a service contract;
 - iv. agrees to fulfill his responsibilities to provide a Deed Notice as required by 310 CMR 15.287(10) and the Approval;
 - v. agrees to fulfill his responsibilities to provide written notification of the Approval to any new owner, as required by 310 CMR 15.287(5);
 - vi. if the design does not provide for the use of garbage grinders, the restriction is understood and accepted;
 - vii. if the design is for an upgrade of failed or nonconforming system, the System Owner has been provided a copy of the evaluation of the existing system;
 - viii. whether or not covered by a warranty, the System Owner understands the requirement to repair, replace, modify or take any other action as required by the Department or the LAA, if the Department or the LAA determines that the Alternative System is not capable of meeting the performance standards; and

- b) A certification, signed by the Designer that the design conforms to the Approval with Conditions and 310 CMR 15.000.

VII. Reporting

All notices and documents required to be submitted to the Department by this Certification shall be submitted to:

Director
Wastewater Management Program
Department of Environmental Protection
One Winter Street - 5th floor
Boston, Massachusetts 02108

VIII. Appeal Rights

In accordance with 310 CMR 15.422. Appeals of Departmental Determinations, any applicant who is aggrieved by a shared system, recirculating sand filter or equivalent alternative technology, a remedial use, a certification for general use, or variance determination by the Department may request an adjudicatory hearing on that determination in accordance with 310 CMR 1.00 and M.G.L. c. 30A..

IX. Rights of the Department

The Department may suspend, modify or revoke this Certification for cause, including, but not limited to, non-compliance with the terms of this Certification, non-payment of any annual compliance assurance fee, for obtaining the Certification by misrepresentation or failure to disclose fully all relevant facts or any change in or discovery of conditions that would constitute grounds for discontinuance of the Certification, or as necessary for the protection of public health, safety, welfare, or the environment, and as authorized by applicable law. The Department reserves its rights to take any enforcement action authorized by law with respect to this Certification and/or the System against the Owner or operator of the System and and/or the Company.



Michael Leitzel, Chairperson
Ellen Doyle Sullivan, Clerk
Donna Barakauskas, Member

TOWN OF BOURNE
Board of Assessors
24 Perry Avenue
Buzzards Bay, MA 02532
(508) 759-0600 Ext. 1510



Rui Pereira, MAA
Director of Assessing

January 17, 2024

Gretchen Dietrich Scott Dietrich
c/o Bracken Engineering, Inc.
49 Herring Pond Rd
Buzzards Bay, MA 02532

Re: Abutters List for Map 42.4 Parcel 34
Property address: 415 Circuit Avenue

As required by the Bourne Board of Health, pursuant with section 310 CMR 15.411(1), this is to certify that the attached list of names and addresses constitutes all of the parties in interest as shown on the most recent tax list of the Town of Bourne.

Abutting properties are: Map 42.4 Parcels 32, 34.01 & 35; Map 43.3 Parcels 137, 138 & 139.

Your filing fee of \$25.00 has been received by the Bourne Assessor's Office.

Please be advised that this abutters list is only good for 30 days from the date on this letter. Expired abutters list can be recertified for an additional filing fee.

See enclosed for abutters mailing addresses.

Board of Assessors

Ellen Doyle Sullivan
Donna Barakauskas
Michael Leitzel

Extract: ABUTTERS LIST
 Database: LIVE
 Filter: Key IN 8928,8931,8932,9425,9426,9427
 Sort:

Report #24: Owner Listing Report
 Fiscal Year 2025

Bourne, MA

Key	Parcel ID	Owner	Location	LC/CI	Bk-Pg(Cert) /Dt	Mailing Street	Mailing City	ST	Zip Cd/County
8928	42.4-32-0	CUDMORE JOHN & CAROLINE GRACE TR CUDMORE & GRACE LIV TRUST	411 CIRCUIT AVE	N 1010	26409/115 6/13/2012	5831 BURNHAM RD	NAPLES	FL	34119
8931	42.4-34-1	REED GUY E III & GRETCHEN S DIETRICH & SCOTT R DIETRICH	0 CIRCUIT AVE	N 1320	29888/66 8/26/2016	PO BOX 318	MONUMENT BEACH	MA	02553
8932	42.4-35-0	BONZAGNI FAMILY NOMINEE TRUST	421 CIRCUIT AVE	N 1010	19306/110 12/2/2004	421 CIRCUIT AVE	POCASSET	MA	02559
9425	43.3-137-0	DUESING JOAN E TRS OF 54 HOPE AVE REALTY TRUST	50 HOPE AVE	N 1010	29463/343 2/22/2016	8765 LAKESIDE BLVD	VERO BEACH	FL	32963
9426	43.3-138-0	DUESING JOAN TRS OF 54 HOPE AVE REALTY TRUST	54 HOPE AVE	N 1320	29463/343 2/22/2016	8765 LAKESIDE RD	VERO BEACH	FL	32963
9427	43.3-139-0	EATON JOHN R & LUCY M EATON TRS OF 59 PEQUOT	58 PEQUOT AVE	N 1010	07686/00266 9/20/1991	PO BOX 1111	POCASSET	MA	02559

Applicant

Total Records 6

MAIN OFFICE:
49 Herring Pond Road
Buzzards Bay, MA 02532
TEL: (508) 833-0070
FAX: (508) 833-2282



NANTUCKET OFFICE:
19 Old South Road
Nantucket, MA 02554
TEL: (508) 325-0044
www.brackeneng.com

January 24, 2024

CERTIFIED MAIL

RE : Notice of Public Hearing

Dear Abutter:

In accordance with the State Environmental Code, Title 5: 310 CMR 15.00, you are hereby notified that **Gretchen Dietrich** has requested a hearing before the Bourne Board of Health for relief from MA 310 15.00 (Title 5) and the Bourne Board of Health Regulations for the installation of an upgraded septic system utilizing Innovative/Alternative technology. The location of the property for which approval is sought is **415 Circuit Avenue (Map 42.4, Parcel 34), Pocasset** where you are listed as an abutter. The following *Local Upgrade Approval Waivers and Local Variances* will be discussed at the hearing:

- **310 CMR 15.405(1)(a) – A 5’ Local Upgrade Approval Waiver from full compliance is requested for a 5’ setback from a property line (#421 Circuit Avenue) to a soil absorption system.**
- **310 CMR 15.405(1)(a) – A 3’ Local Upgrade Approval Waiver from full compliance is requested for a 7’ setback from a property line (#421 Circuit Avenue) to a pump chamber.**
- **310 CMR 15.405(1)(a) – A 4’ Local Upgrade Approval Waiver from full compliance is requested for a 6’ setback from a property line (#54 Hope Avenue) to a septic tank.**
- **310 CMR 15.405(1)(a) – A 5’ Local Upgrade Approval Waiver from full compliance is requested for a 5’ setback from a property line (#54 Hope Avenue) to a pump chamber.**
- **310 CMR 15.405(1)(a) – A 1’ Local Upgrade Approval Waiver from full compliance is requested for a 4’ setback from a foundation (#415 Circuit Avenue) to a soil absorption system.**
- **An 84’ local variance is requested from the BOURNE BOARD OF HEALTH Regulations for a 66’ setback from a proposed soil absorption system to the top of a Coastal Bank.**
- **A 62’ local variance is requested from the BOURNE BOARD OF HEALTH Regulations for an 88’ setback from a proposed soil absorption system to the Mean High Water line of Pocasset Harbor.**

This hearing is **tentatively** scheduled for Wednesday, February 14th at **5:30 p.m.** in Conference Room #2 at the Bourne Veteran’s Memorial Community Building, 239 Main Street, Buzzards Bay. ***Please confirm the date, time and location of the meeting with the Town, in case of any changes.*** Information regarding the hearing may be available for your review one week prior to the meeting by contacting the Bourne Health Department at 508-790-0600, Ext. 1513, Monday through Friday from 8:30 a.m. until 4:30 p.m.

Meeting agendas are posted on the Town of Bourne website, www.townofbourne.com/health no less than 48 hours in advance of the hearing. Should you have any questions or concerns, please do not hesitate to contact the undersigned at zac@brackeneng.com or the Bourne Health Department at 508-790-0600, Ext. 1513.

Sincerely,

BRACKEN ENGINEERING INC.

A handwritten signature in black ink, appearing to read 'Zachary L. Basinski', is written over a horizontal line.

Zachary L. Basinski, PE, CFM
Senior Project Manager
Agent for the Applicant

9589 0710 5270 1225 2482 29

U.S. Postal Service™
CERTIFIED MAIL® RECEIPT
Domestic Mail Only

For delivery information, visit our website at www.usps.com®.

OFFICIAL USE

Postage: \$.64
Certified Fee: \$ 4.40
Return Receipt Fee: \$ 3.65
Total Postage & Fees: \$ 8.69



JOAN E. DUESING, TRS
54 HOPE AVE REALTY TRUST
8765 LAKESIDE BLVD
VERO BEACH, FL 32963

415 CIRCUIT AVE., BOURNE - BOH

PS Form 3800, January 2023 PSN 7530-02-000-9047 See Reverse for Instructions

9589 0710 5270 1225 2482 12

U.S. Postal Service™
CERTIFIED MAIL® RECEIPT
Domestic Mail Only

For delivery information, visit our website at www.usps.com®.

OFFICIAL USE

Postage: \$.64
Certified Fee: \$ 4.40
Return Receipt Fee: \$ 3.65
Total Postage & Fees: \$ 8.69



BONZAGNI FAMILY NOMINEE TR
421 CIRCUIT AVENUE
POCASSET, MA 02559

415 CIRCUIT AVE., BOURNE - BOH

PS Form 3800, January 2023 PSN 7530-02-000-9047 See Reverse for Instructions

9589 0710 5270 1225 2482 36

U.S. Postal Service™
CERTIFIED MAIL® RECEIPT
Domestic Mail Only

For delivery information, visit our website at www.usps.com®.

OFFICIAL USE

Postage: \$.64
Certified Fee: \$ 4.40
Return Receipt Fee: \$ 3.65
Total Postage & Fees: \$ 8.69



JOHN R. EATON
LUCY M EATON TRS
59 PEQUOT AVE REALTY TRUST
PO BOX 1111
POCASSET, MA 02559

415 CIRCUIT AVE., BOURNE - BOH

PS Form 3800, January 2023 PSN 7530-02-000-9047 See Reverse for Instructions

9589 0710 5270 1225 2482 05

U.S. Postal Service™
CERTIFIED MAIL® RECEIPT
Domestic Mail Only

For delivery information, visit our website at www.usps.com®.

OFFICIAL USE

Postage: \$.64
Certified Fee: \$ 4.40
Return Receipt Fee: \$ 3.65
Total Postage & Fees: \$ 8.69



JOHN CUDMORE &
CAROLINE GRACE TRS
Cudmore & Grace Liv Trust
5891 BURNHAM ROAD
NAPLES, FL 34119

415 CIRCUIT AVE., BOURNE - BOH

PS Form 3800, January 2023 PSN 7530-02-000-9047 See Reverse for Instructions

MASS COORDINATE SYSTEM
 MAINLAND ZONE MERIDIAN
 DETERMINED USING A
 CARLSON BR7 GPS RTK UNIT
 COLLECTION DATE 4/18/2023

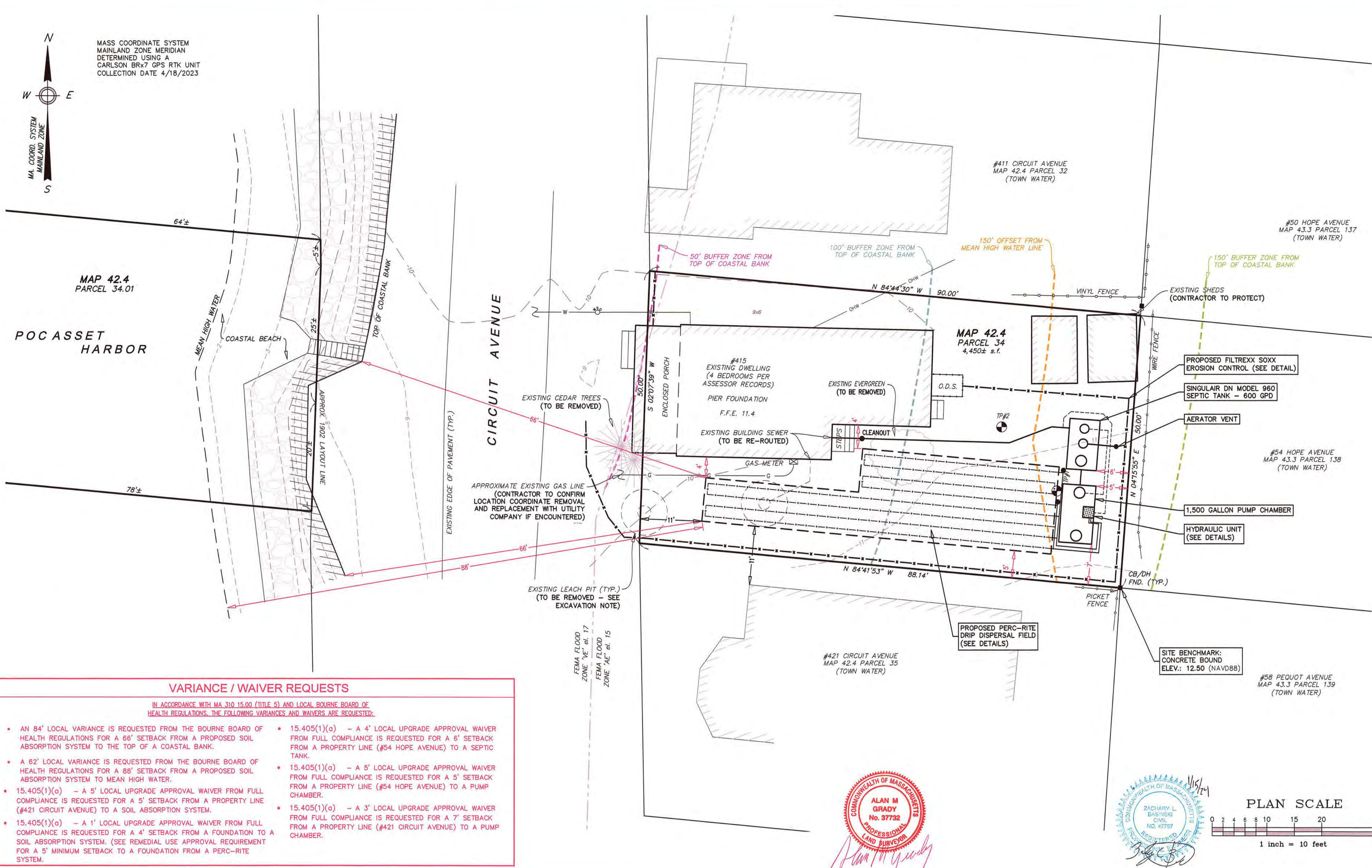

EXCAVATION NOTE

THIS SYSTEM WILL REQUIRE THE EXCAVATION OF ALL SPOILED AND UNSUITABLE SOIL BELOW THE PROPOSED SOIL ABSORPTION SYSTEM TO THE C1 SAND LAYER. ENGINEER TO CONFIRM SOIL DEPTH / REMOVAL LIMITS PRIOR TO INSTALLATION. THE EXCAVATION SHALL BE INSPECTED BY THE DESIGN ENGINEER PRIOR TO BACKFILLING. SOIL IS TO BE REPLACED WITH SAND CONFORMING TO 310 CMR SECTION 15.255. CONSTRUCTION IN FILL. CONTRACTOR IS RESPONSIBLE TO PROVIDE ENGINEER WITH SAND SAMPLE FOR SIEVE ANALYSIS.

DESIGN CALCULATIONS

SOIL TEXTURAL CLASS: CLASS II
 DESIGN PERC. RATE: 15 MPI
 NO. OF BEDROOMS: 4 BEDROOMS
 DESIGN FLOW REQUIRED: 440 GPD
 SEPTIC TANK REQUIRED: 1,500 GALLONS
 SEPTIC TANK PROVIDED: SINGULAR DN 960 - 600 GPD
 PUMP CHAMBER PROVIDED: 1,500 GALLON PUMP CHAMBER

LEACHING SYSTEM:
 PERC-RITE DRIP DISPOSAL IRRIGATION SYSTEM
 EFFECTIVE FIELD TO BE 800 SF EFFECTIVE AREA WITH 405 LF TOTAL OF PERC-RITE DRIP TUBING

EFFECTIVE LEACHING: (BASED ON REMEDIAL USE APPROVAL)
 LOADING RATE = 0.56 GPD/SF.
 (440 GPD)/(0.56 GPD/SF) = 786 S.F. REQUIRED BED (786 S.F.)/(2 S.F./L.F. DRIP TUBING) = 393 L.F. REQ. TUBING

(800 S.F. PROVIDED)(0.56 GPD/SF) = 448 GPD > 440 GPD
 405 L.F. TUBING PROVIDED AT 2.0' O.C.

SOIL LOGS

TP NO.	1	2
GRD. EL.	11.3	10.7
GW. EL.	NONE TO 1.3	NONE TO 0.3
0"	FILL / DISTURBED SOIL	A/FILL LOAMY SAND 10YR 3/2
36"	C1 MEDIUM SAND 10YR 6/4	B MEDIUM SAND 10YR 5/4
80"	C2 MEDIUM LOAMY SAND 2.5Y 6/1	C1 MEDIUM SAND 10YR 6/4
120"	NO MOTTLING NO WATER	C2 MEDIUM LOAMY SAND 2.5Y 6/1

DATE PERFORMED: JUNE 6, 2023
 SOIL EVALUATOR: ROBERT E. DEWAR - SE #14230
 WITNESSED BY: T. GUARINO, HEALTH AGENT
 PERC. RATE: 15 MINUTES/INCH
 SOIL CLASS: CLASS II
 MAX. GROUND WATER ELEV.: NONE TO EL. 0.7
 METHOD OF DETERMINATION: NO MOTTLING NO WATER
 (SEE SOIL REPORT FOR MORE DETAILED DESCRIPTION)

VARIANCE / WAIVER REQUESTS

IN ACCORDANCE WITH MA 310 15.00 (TITLE 5) AND LOCAL BOURNE BOARD OF HEALTH REGULATIONS, THE FOLLOWING VARIANCES AND WAIVERS ARE REQUESTED:

- AN 84' LOCAL VARIANCE IS REQUESTED FROM THE BOURNE BOARD OF HEALTH REGULATIONS FOR A 86' SETBACK FROM A PROPOSED SOIL ABSORPTION SYSTEM TO THE TOP OF A COASTAL BANK.
- A 62' LOCAL VARIANCE IS REQUESTED FROM THE BOURNE BOARD OF HEALTH REGULATIONS FOR A 86' SETBACK FROM A PROPOSED SOIL ABSORPTION SYSTEM TO MEAN HIGH WATER.
- 15,405(1)(a) - A 5' LOCAL UPGRADE APPROVAL WAIVER FROM FULL COMPLIANCE IS REQUESTED FOR A 5' SETBACK FROM A PROPERTY LINE (#421 CIRCUIT AVENUE) TO A SOIL ABSORPTION SYSTEM.
- 15,405(1)(a) - A 1' LOCAL UPGRADE APPROVAL WAIVER FROM FULL COMPLIANCE IS REQUESTED FOR A 4' SETBACK FROM A FOUNDATION TO A SOIL ABSORPTION SYSTEM. (SEE REMEDIAL USE APPROVAL REQUIREMENT FOR A 5' MINIMUM SETBACK TO A FOUNDATION FROM A PERC-RITE SYSTEM.)
- 15,405(1)(g) - A 4' LOCAL UPGRADE APPROVAL WAIVER FROM FULL COMPLIANCE IS REQUESTED FOR A 8' SETBACK FROM A PROPERTY LINE (#54 HOPE AVENUE) TO A SEPTIC TANK.
- 15,405(1)(g) - A 5' LOCAL UPGRADE APPROVAL WAIVER FROM FULL COMPLIANCE IS REQUESTED FOR A 5' SETBACK FROM A PROPERTY LINE (#54 HOPE AVENUE) TO A PUMP CHAMBER.
- 15,405(1)(g) - A 3' LOCAL UPGRADE APPROVAL WAIVER FROM FULL COMPLIANCE IS REQUESTED FOR A 7' SETBACK FROM A PROPERTY LINE (#421 CIRCUIT AVENUE) TO A PUMP CHAMBER.

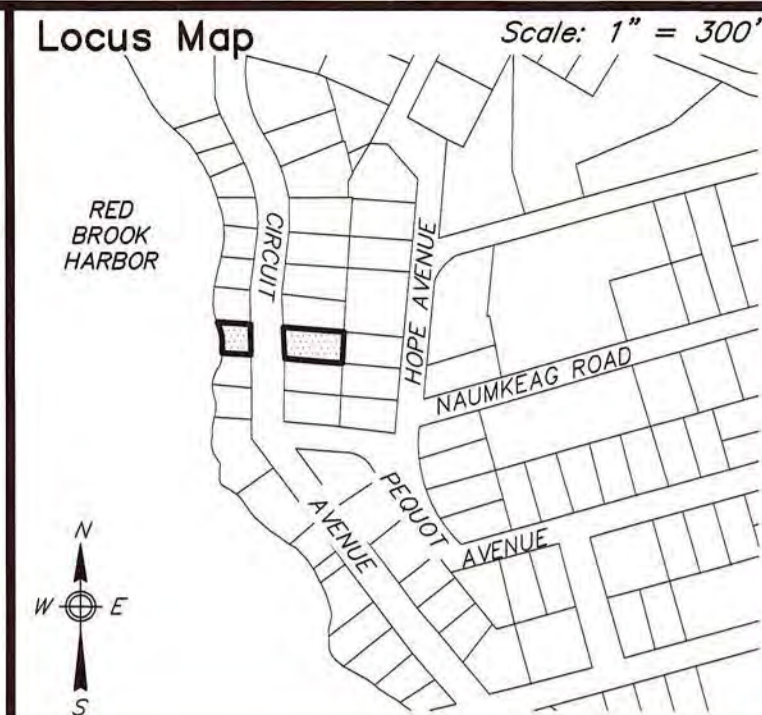

- Notes**
- BENCHMARK: ELEVATION = 12.50 (NAVD88) TOP OF CONCRETE BOUND.
 - ALL CONSTRUCTION METHODS AND MATERIALS TO CONFORM TO TITLE 5 AND THE TOWN OF BOURNE BOARD OF HEALTH REGULATIONS.
 - ALL SYSTEM COMPONENTS SHALL BE MARKED WITH MAGNETIC TAPE OR A COMPARABLE MEANS IN ORDER TO LOCATE THEM ONCE BURIED.
 - NO FIELD MODIFICATION TO THE SYSTEM SHALL BE MADE WITHOUT PRIOR WRITTEN APPROVAL OF THE DESIGN ENGINEER AND BOARD OF HEALTH.
 - ALL JOINTS AND COVERS TO BE WATERTIGHT.
 - THE CONTRACTOR SHALL BE RESPONSIBLE FOR VERIFYING THE ACTUAL LOCATION OF ANY EXISTING UTILITIES.
 - A CERTIFICATE OF COMPLIANCE MUST BE OBTAINED PRIOR TO BACKFILLING SYSTEM.
 - OWNER: GRETCHEN S. DIETRICH, SCOTT R. DIETRICH, P.O. BOX 15, MONUMENT BEACH, MA 02553
 - DEED REFERENCE: Deed Bk: 29888 Pg: 66
 - PLAN REFERENCE: Plan Bk: 28 Pg: 1 (LOT 34)
 - THIS DESIGN IS INTENDED TO MEET TITLE 5 AND OTHER APPLICABLE REQUIREMENTS. THIS PLAN DOES NOT GUARANTEE THAT THE SYSTEM WILL BE INSTALLED AS DESIGNED, NOR DOES THIS PLAN GUARANTEE THE OPERATION OF THE SYSTEM.
 - THIS SYSTEM IS NOT DESIGNED NOR INTENDED FOR USE WITH A GARBAGE GRINDER.
 - THE SYSTEM OWNER SHALL BE RESPONSIBLE TO PUMP THE SEPTIC TANK AT LEAST ONCE EVERY THREE YEARS.
 - LOCUS DOES NOT FALL WITHIN A ZONE II WELLHEAD PROTECTION AREA OR BOURNE WATER RESOURCE DISTRICT.
 - LOCUS DOES NOT FALL WITHIN AN NHESP ESTIMATED HABITAT OF RARE WILDLIFE AND PRIORITY HABITAT OF RARE SPECIES.
 - LOCUS DOES FALL WITHIN A SPECIAL FLOOD HAZARD ZONE "AE" (EL. 15) AND "AE" (EL. 17) AS SHOWN ON FEMA FLOOD INSURANCE RATE MAP No. 25001C-0492-J, dated 7/16/2014.
 - CONTRACTOR TO REFER TO ALL MANUFACTURER'S REQUIREMENTS AND SPECIFICATIONS FOR INSTALLATION OF THE SINGULAR UNIT AND PERC-RITE DRIP DISPERSAL SYSTEM.
 - RECORD PROPERTY OWNER IS TO FILE A NOTICE OF DEED RESTRICTION AT THE BARNSTABLE COUNTY REGISTRY OF DEEDS PRIOR TO THE INSTALLATION OF THE SYSTEM, INDICATING THE USE OF AN INNOVATIVE/ALTERNATIVE SEPTIC SYSTEM ON THE PROPERTY.
 - HOMEOWNER IS TO ESTABLISH AN OPERATION & MAINTENANCE PLAN WITH A COMPANY CERTIFIED SYSTEM OPERATOR FOR THE SINGULAR UNIT & PERC RITE SYSTEM. ALL SYSTEM TESTING, MONITORING & REPORTING IS TO BE CONDUCTED IN ACCORDANCE TO THE MASSACHUSETTS DEPARTMENT OF ENVIRONMENTAL PROTECTION (DEP) GENERAL USE PERMITS.
 - CONTRACTOR TO COORDINATE PLACEMENT OF ALL ALARM/CONTROL PANELS WITH THE HOMEOWNER & SYSTEM MANUFACTURERS PRIOR TO INSTALLATION. ALL PANELS SHALL BE ELEVATED ABOVE THE DESIGN FLOOD ELEVATION 16.
 - SOIL CONDITIONS ENCOUNTERED DURING EXCAVATION MAY DIFFER FROM THE PREVIOUSLY OBSERVED CONDITIONS AT THE TEST PITS. ADDITIONAL REMOVAL AND REPLACEMENT OF SOIL MAY BE REQUIRED, IF UNDESIRABLE CONDITIONS ARE ENCOUNTERED THE DESIGN ENGINEER SHALL BE CONSULTED.

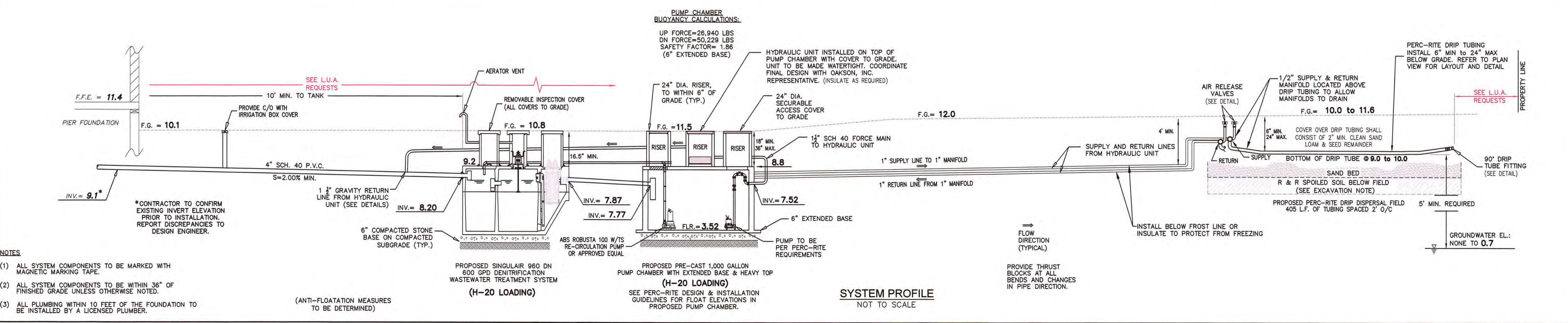
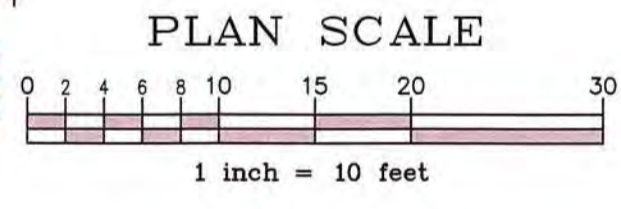

Prepared By:
BRACKEN ENGINEERING, INC.
 49 HERRING POND ROAD BUZZARDS BAY, MA 02552 (tel) 508.833.0070 (fax) 508.833.2282
 19 OLD SOUTH ROAD NANTUCKET, MA 02554 (tel) 508.325.0044 (www.brackeneng.com)

SEWAGE DISPOSAL PLAN IN BOURNE, MASSACHUSETTS

Prepared For:
GRETCHEN S. DIETRICH
SCOTT R. DIETRICH
 #415 CIRCUIT AVENUE
 MAP 42.4 PARCEL 34

No.	Date	Revision Description	By
1	JANUARY 15, 2024		JPH/BEI
2			ZBL/AMG
3			

Checked: [] Sheet: 1 of 2

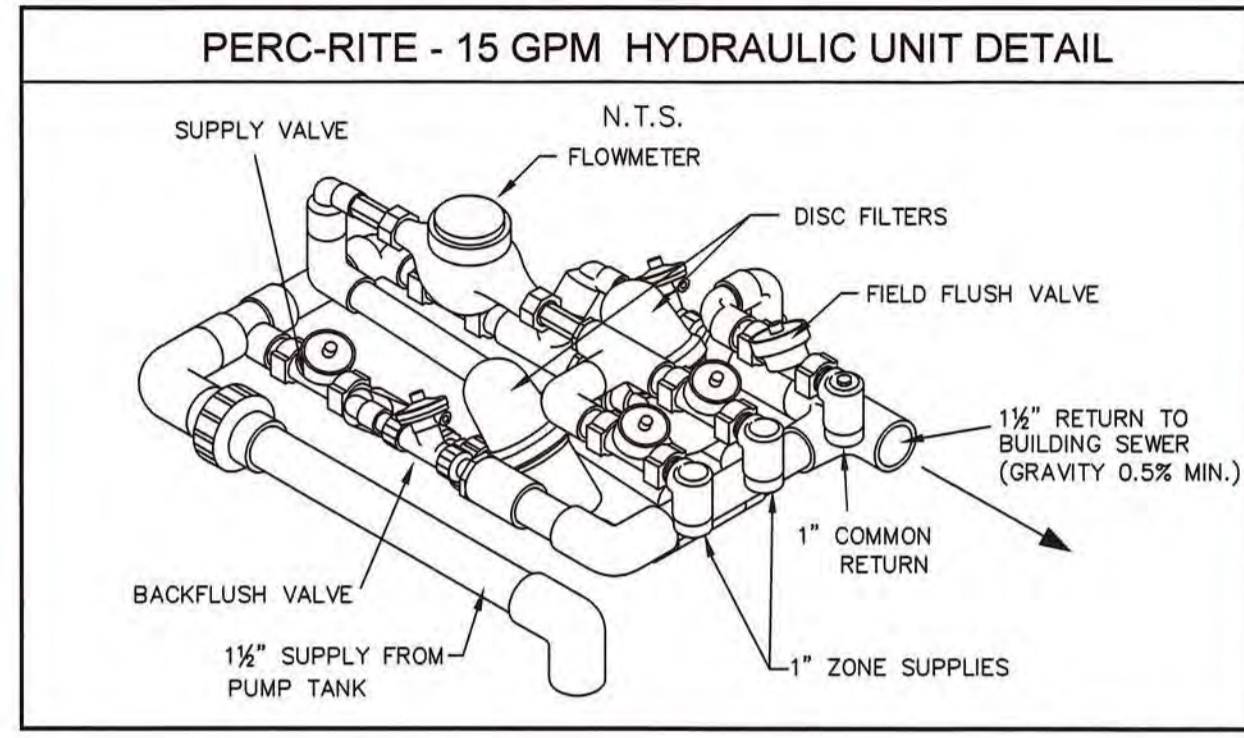
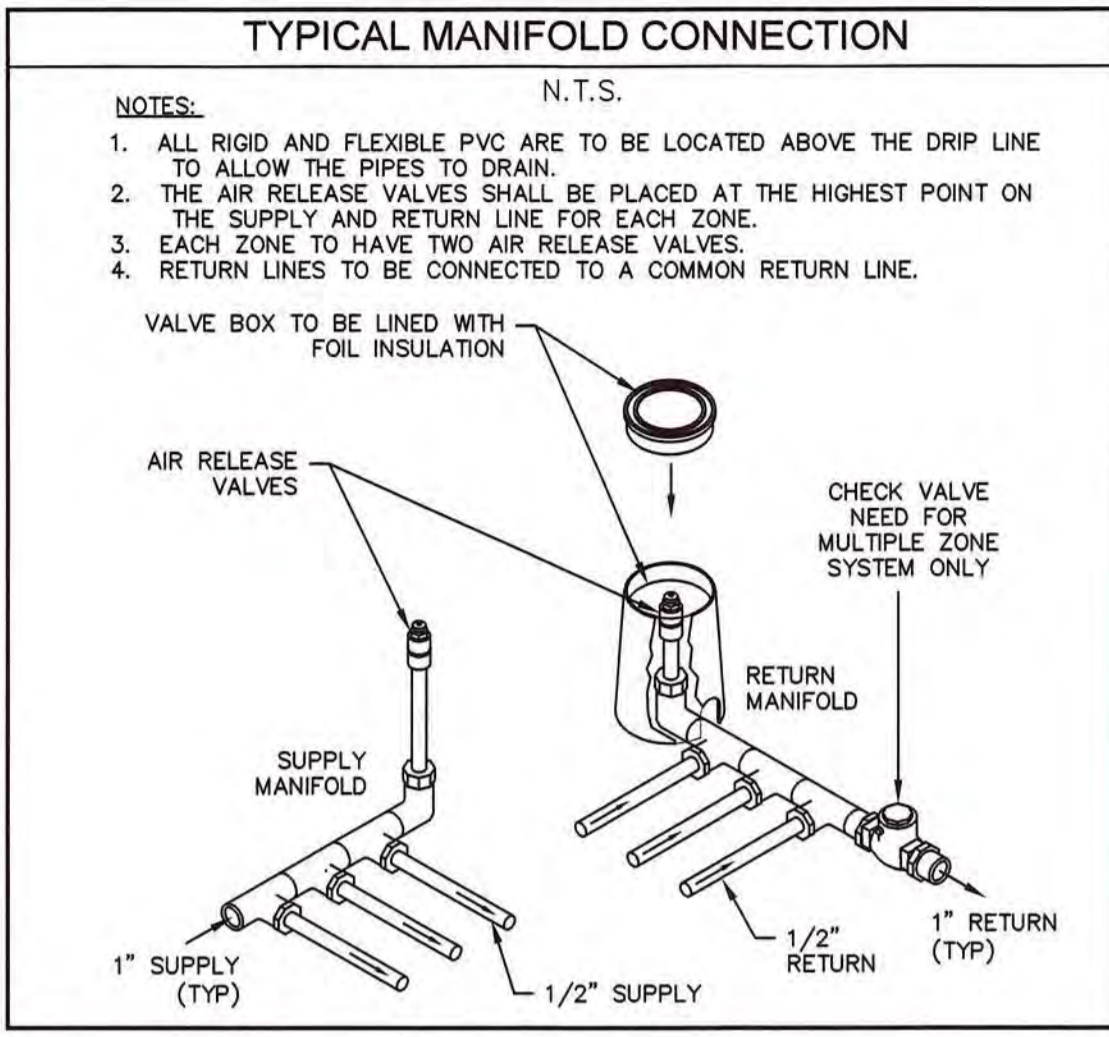
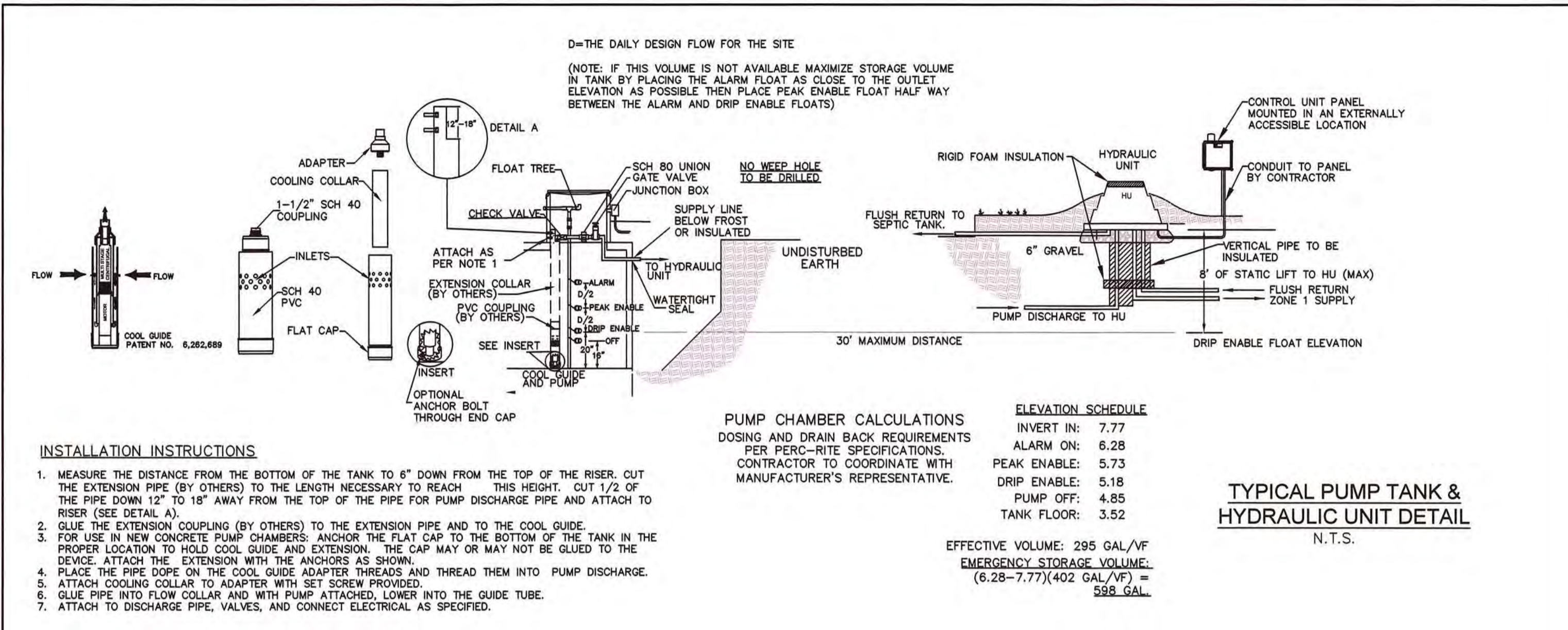

- GENERAL CONSTRUCTION NOTES - "PERC-RITE" DRIP DISPERSAL SYSTEMS**
- THE SYSTEM SHALL NOT BE INSTALLED IN WET OR FROZEN SOILS.
 - DO NOT PARK, DRIVE LARGE EQUIPMENT, OR STORE MATERIALS ON THE DISPERSAL AREA. NO ACTIVITY SHOULD OCCUR ON DISPERSAL AREA OTHER THAN THE MINIMUM REQUIRED TO INSTALL THE SYSTEM.
 - ALL INSTALLATION AND CONSTRUCTION TECHNIQUES SHALL CONFORM TO STATE AND LOCAL CODES PERTAINING TO ON-SITE SEWAGE SYSTEMS AND THE PERMIT FOR THE SITE.
 - THE INSTALLATION SHALL BE IN ACCORDANCE WITH SPECIFICATIONS AND PROCEDURES AS SUPPLIED BY THE MANUFACTURER OF THE EQUIPMENT.
 - THE CONTRACTOR SHALL BE CERTIFIED TO INSTALL THIS TYPE OF SYSTEM AND SHOULD HOLD A PRE-CONSTRUCTION MEETING WITH THE INDIVIDUALS RESPONSIBLE FOR THE SITE DESIGN AND INSPECTIONS. THE MEETING SHOULD BE HELD PRIOR TO THE BEGINNING OF THE SITE WORK TO ENSURE PROTECTION OF THE SITE CONDITIONS AND TO ENSURE THAT THE SYSTEM IS INSTALLED ACCORDING TO DESIGN.
 - IF SITE CONDITIONS ARE DETERMINED TO REQUIRE THE INSTALLATION OF THE SYSTEM TO DEVIATE FROM THE DESIGN PLANS, ALL WORK SHALL STOP IMMEDIATELY AND THE DESIGNER AND HEALTH AGENT SHALL BE NOTIFIED. ANY ON GOING WORK SHALL BE THE SOLE RESPONSIBILITY OF THE CONTRACTOR.
 - DRIP TUBING MAY BE INSTALLED WITH A VIBRATORY FLOW, A STATIC FLOW, A NARROW TRENCHER (<8" WIDTH), BY HAND TRENCHING, OR BY SCARIFYING THE SURFACE AND BEDDING THE DRIP TUBING IN CLEAN SAND MEETING THE REQUIREMENTS FOR FILL MATERIAL IN TITLE 6 AT 310 CMR 15.255(3) WITH COVER CONSISTING OF SAND AND TOPSOIL MEETING THE 6" TO 12" DEPTH REQUIREMENT THE DESIGNER MAY INDICATE FOR THE TUBING TO BE INSTALLED TO 24" BELOW GRADE. ALL DRIP TUBING IS TO BE INSTALLED PARALLEL WITH THE CONTOUR. VEGETATIVE COVER MUST BE REPLACED FOR INSTALLATIONS WHERE IT IS REMOVED OR BURIED DURING INSTALLATION.
 - ALL CUTTING OF RIGID PVC PIPE, FLEXIBLE PVC AND DRIP TUBING OF SIZE 1 1/2" OR SMALLER SHALL BE ACCOMPLISHED WITH PIPE CUTTERS APPROVED BY MANUFACTURER. NO SAWING OF PVC, FLEXIBLE PVC OR DRIP TUBING OF SIZE 1 1/2" OR SMALLER. ALL RIGID PVC PIPE, FLEXIBLE PVC AND DRIP TUBING IN THE WORK AREA SHALL HAVE THE ENDS COVERED WITH DUCT TAPE AFTER CUTTING TO PREVENT CONSTRUCTION DEBRIS FROM ENTERING THE PIPE. PRIOR TO GLUING, ALL JOINTS SHALL BE INSPECTED. ALL PVC PIPE AND FITTINGS IN THE FIELD SHALL BE SCH 40. ALL GLUED JOINTS SHALL BE CLEANED AND FOR AND CLEARED OF ANY DEBRIS. PRIMED WITH PVC PRIMER PRIOR TO BEING GLUED. ALL FORGE MAINS SHALL BE TESTED FOR LEAKS PRIOR TO BEING BACKFILLED BY PRESSURIZING THE SYSTEM AND OBSERVING FOR LEAKAGE.
 - THE HYDRAULIC UNIT IS TO BE PLACED ON A BED OF 4"- 6" THICK OF 3/4" - 1 1/2" GRAVEL FOR DRAINAGE IF STANDING GROUNDWATER IS A PROBLEM IN THE VICINITY OF THE HYDRAULIC UNIT, A SCREENED DRAIN TO DAYLIGHT IS REQUIRED.
- COLD CLIMATE CONSTRUCTION STANDARDS - "PERC-RITE" DRIP DISPERSAL SYSTEMS**
- ALL ATTEMPTS SHOULD BE MADE TO PLACE THE HYDRAULIC UNIT WITH AN OPEN SOUTHERN EXPOSURE FOR WARMING PURPOSES.
 - THE SUPPLY AND RETURN LINES SHALL BE INSTALLED BELOW THE FROST LINE. THE VERTICAL SECTIONS OF PIPE THAT CONNECT TO THE SUPPLY AND RETURN LINES SHALL BE INSULATED SCH 40 PVC PIPE. INSULATION SHALL BE MINIMUM 1/2" THICK FOAM (OR 1/2" RIGID FOAM INSULATION MAY BE INSTALLED UNDER THE HYDRAULIC UNIT TO PROTECT THE SUPPLY AND RETURN LINES IN EXTREME CONDITIONS) SUFFICIENT GROUND COVER AROUND THE HYDRAULIC UNIT IS REQUIRED FOR INSULATION. ALL PIPES ENTERING AND LEAVING THE HYDRAULIC UNIT SHALL ELBOW VERTICALLY DOWN 90 DEGREES TO A DEPTH BELOW THE FROST LINE PRIOR TO EXTENDING AWAY FROM THE UNIT HORIZONTALLY. ADDITIONAL INSULATION INSIDE THE HYDRAULIC UNIT IS ENCOURAGED. INSULATION TO CONSIST OF BLUE BOARD, BAGGED STYROFOAM, PEANUTS OR EQUIVALENT. IF FIBERGLASS INSULATION IS USED IT MUST BE SEALED TO PREVENT IT FROM BECOMING SATURATED.
 - DENSE VEGETATIVE COVER IS TO BE ESTABLISHED OVER THE SUPPLY TRENCH, RETURN TRENCH AND DRIP TUBING PRIOR TO THE FIRST EXPOSURE TO FREEZING TEMPERATURES. IF VEGETATION CANNOT BE ESTABLISHED, THEN TRENCHES AND TUBING ARE TO BE COVERED WITH A THICK LAYER (MINIMUM 6") OF MULCH, STRAW/HAY, ETC. UNTIL SUCH TURF COVER IS ESTABLISHED. ESTABLISHED VEGETATION HEIGHT OVER THE DISPERSAL AREA SHOULD BE A MINIMUM 4"-6" THROUGHOUT WINTER MONTHS.
 - CONTRACTOR SHALL INSULATE ALL "AIR RELEASE VALVES." INSULATION TO CONSIST OF BLUE BOARD, BAGGED STYROFOAM PEANUTS, OR EQUIVALENT. IF FIBERGLASS INSULATION IS USED, IT MUST BE SEALED TO PREVENT IT FROM BECOMING SATURATED. RELEASE VALVES SHALL BE PLACED BELOW THE GROUND SURFACE INSIDE A VALVE BOX BUT AT AN ELEVATION ABOVE THE HIGHEST DRIP LINE IN THAT PARTICULAR ZONE.
 - ALL LOOPS CONNECTING DRIP RUNS SHALL BE SLIGHTLY ELEVATED (MINIMUM 1" - 2") SO THAT THEY DRAIN INTO THE DRIP TUBING AFTER THE PUMP SHUTS OFF. IT IS THE CONTRACTOR'S RESPONSIBILITY TO ENSURE THESE LOOPS STAY ELEVATED DURING AND AFTER THE LOOPS ARE BACKFILLED.
 - ALL CONDUIT ENTERING INTO THE CONTROL PANEL SHALL BE SEALED TO PREVENT CONDENSATION INSIDE THE PANEL.

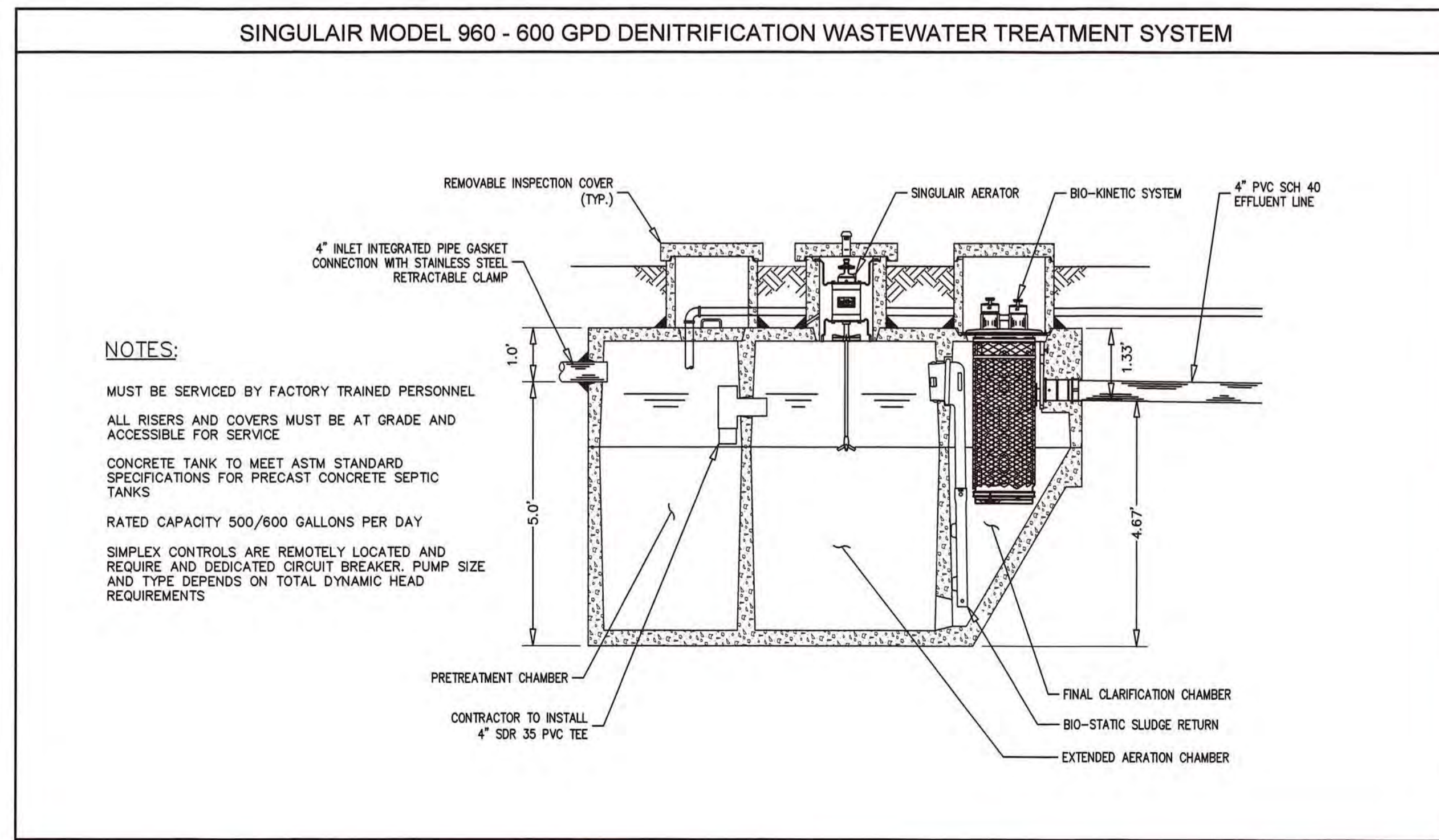
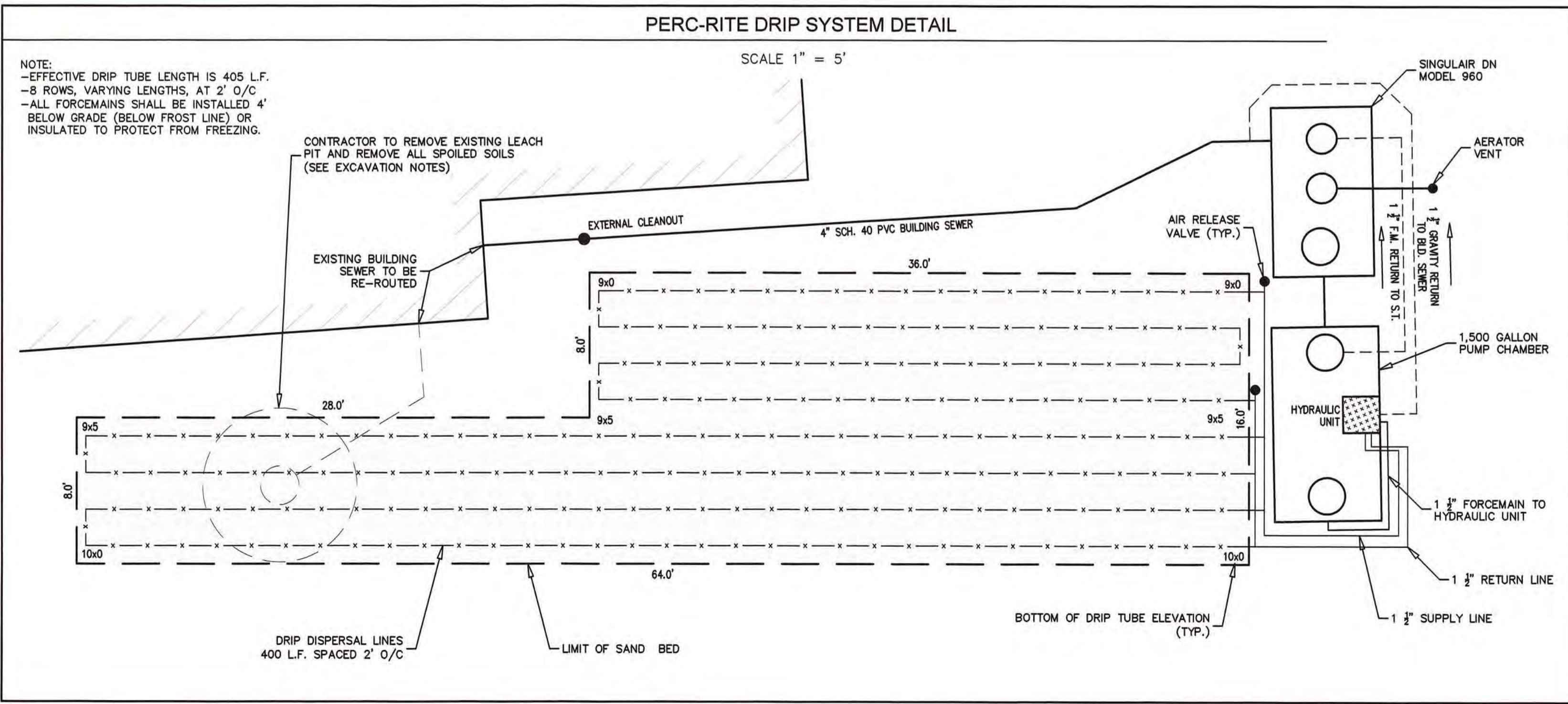
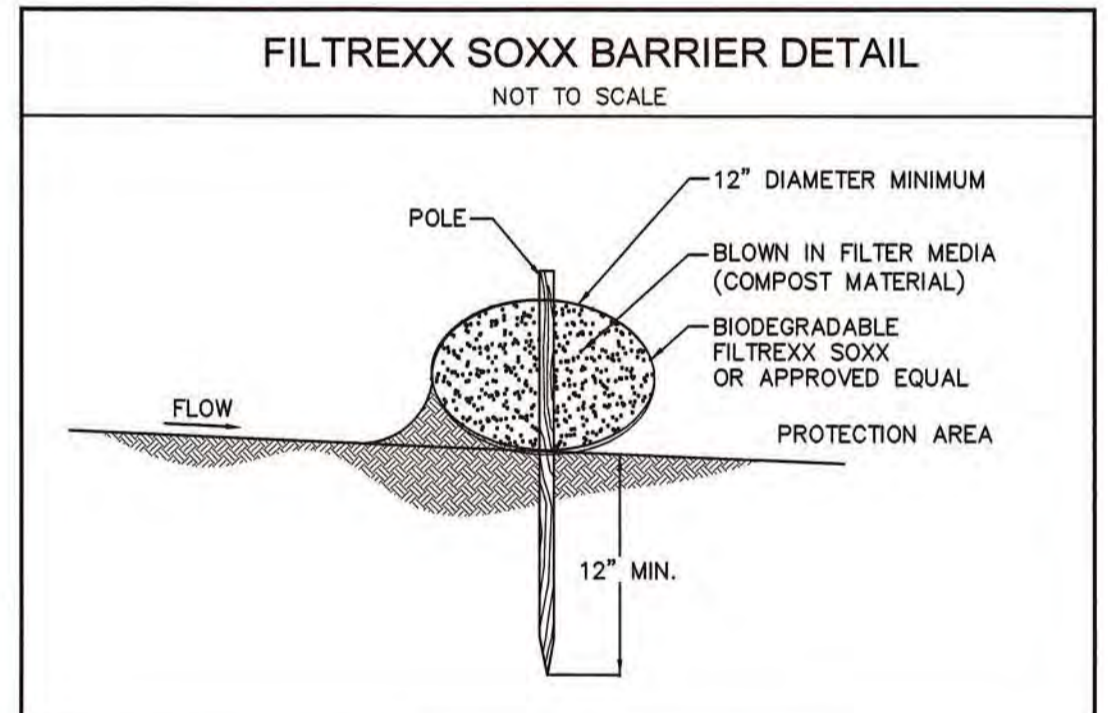
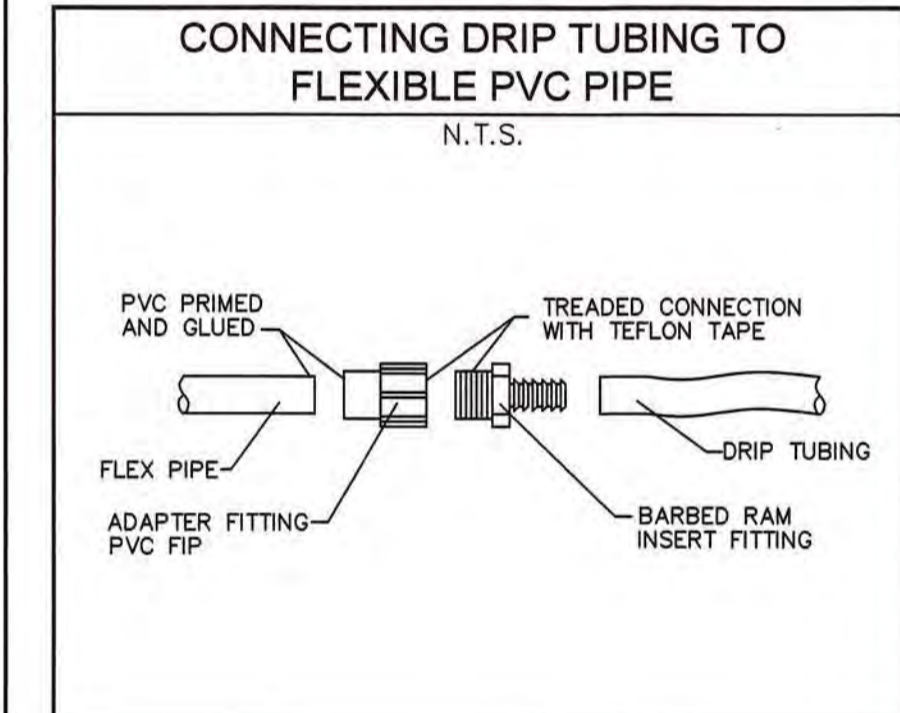
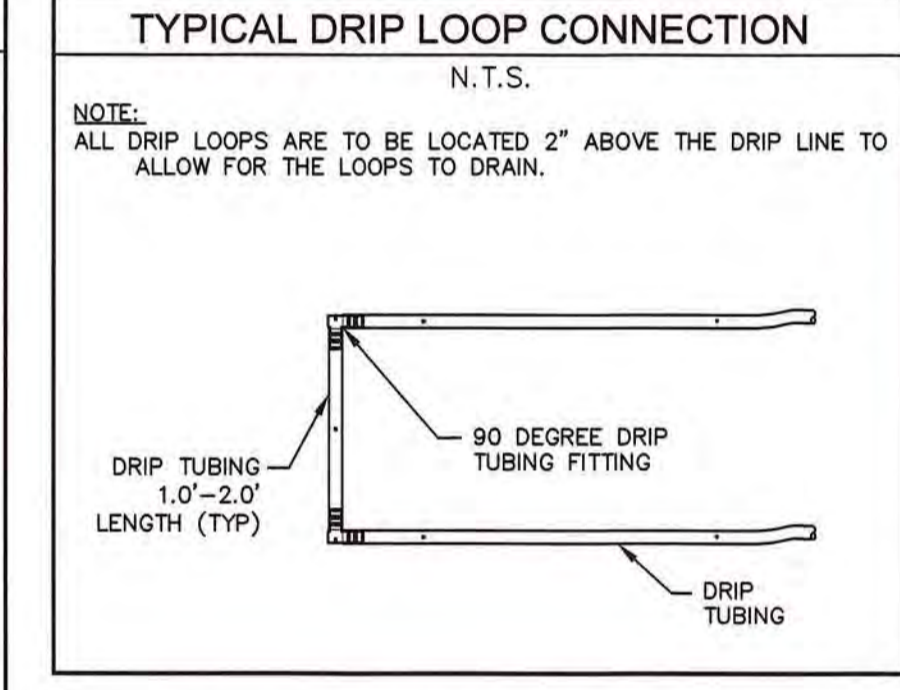
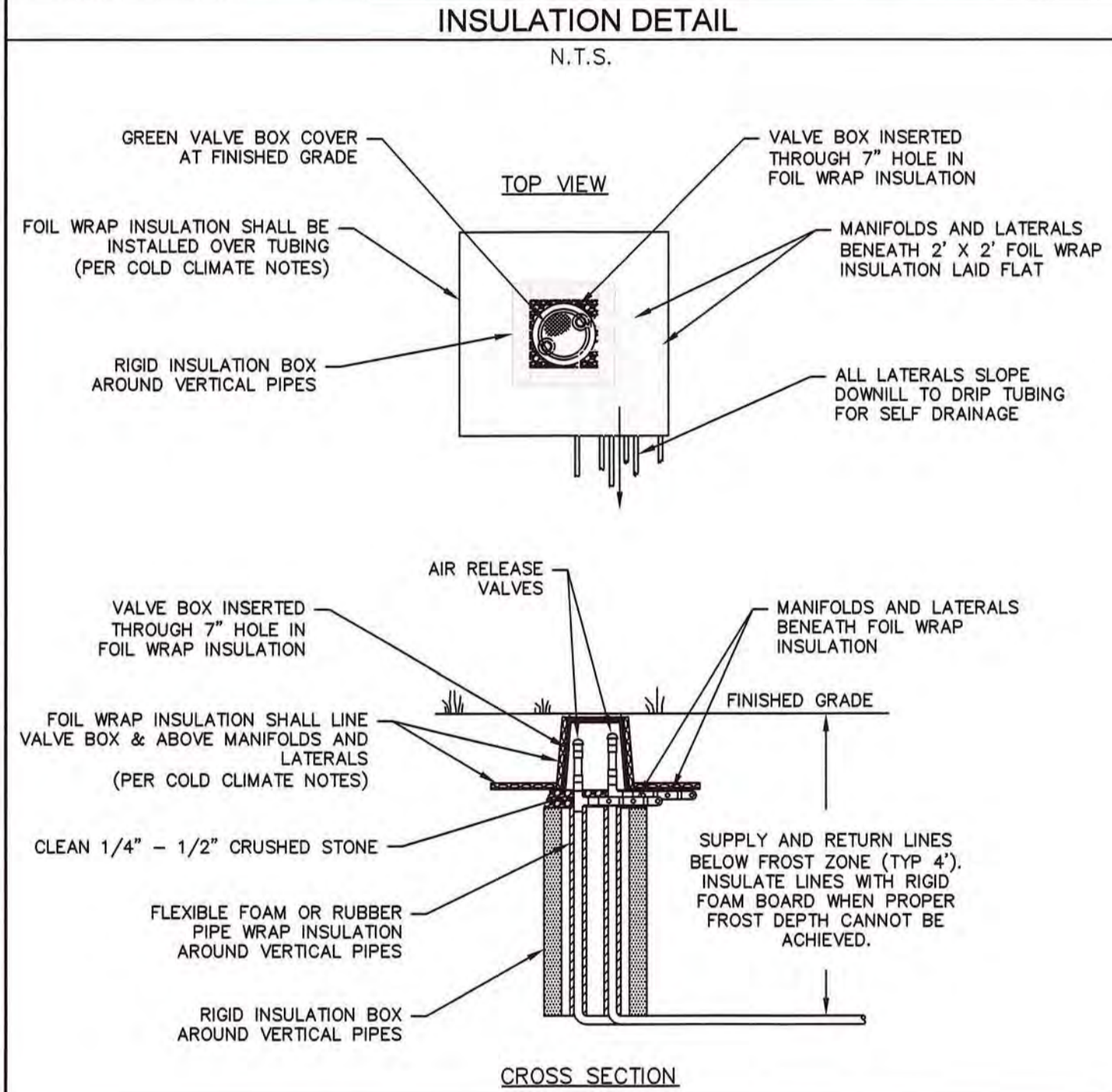

DIG SAFE
CALL 72 HOURS BEFORE YOU DIG
Call: TOLL FREE
1-888-344-7233
1-888-DIG-SAFE

Prepared By:
BRACKEN ENGINEERING, INC.
49 HERRING POND ROAD BUZZARDS BAY, MA 02532
(tel) 508.833.0070 (fax) 508.833.2282
19 OLD SOUTH ROAD NANTUCKET, MA 02554
(tel) 508.325.0044 (www.brackeneng.com)

DETAIL SHEET IN BOURNE, MASSACHUSETTS
Prepared For:
GRETCHEN S. DIETRICH
SCOTT R. DIETRICH
#415 CIRCUIT AVENUE
MAP 42.4 PARCEL 34

No.	Date	Revision Description	By

Date: JANUARY 15, 2024
Drawn: JPH/BEI
Checked: ZLB/AMG
Sheet: 2 of 2